

Alias



TEC 1400 - 634

Modular table with structure in die-cast and extruded aluminium. Top in plywood Full Color or lacquered glass.





design
Alfredo Häberli

Tec is an elementary modular table features slender legs in die-cast aluminium that are hooked onto an extruded aluminium structure set back relative to the edge of the table top. On the one hand, this configuration achieves an interesting visual effect as the top seems to be floating in the air and, on the other hand, thanks to the structure's rigidity, it is able to support extremely long tops thereby making it possible to choose from a very broad range of sizes.

Depending on the material used, the table top can be had in different versions: from an extremely thin white full color top to a painted glass top available in a variety of colours or a whitened oak version, or a white bilaminate top. The legs and structure can be painted in a choice of four colours: white, yellow, aubergine or a new anodized coating.

An important extension of the tec collection presents the introduction of an extendables versions. The white bilaminate top together with the white full color and bleached oak hues, is the distinctive trait of this collection, which comes in five different sizes. The expansion mechanism built into the structure is simple and functional: a practical solution that makes the tec table ideally suited for use in the widest variety of settings and applications.

Dimension

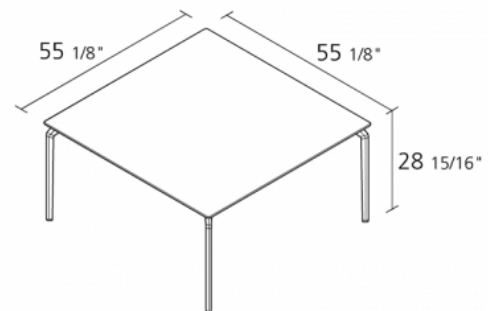
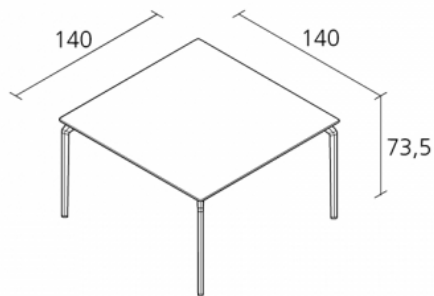

Year warranty: 10 years

Production time: weeks

Gallery



Finiture

stove enamelled aluminium



coloured glass

