



PORTUS

BENCH / EASY CHAIR / SOFA
DESIGN JOHANNES FOERSOM & PETER HIORT-LORENZEN

PORTUS ÄR EN ARKITEKTONISK PRODUKTFAMILJ
MED EN TYDLIG VISUELL IDENTITET.

Formgivare Johannes Foersom & Peter Hiort-Lorenzen

PORTUS IS AN ARCHITECTURAL FAMILY OF
PRODUCTS WITH A CLEAR VISUAL IDENTITY

Designers Johannes Foersom & Peter Hiort-Lorenzen

Bänk 2-sits / Bench 2-seater



Fåtölj låg rygg / Easy chair low back



2-sits soffa hög rygg / 2-seater sofa high back



3-sits soffa / 3-seater sofa







FÁTÖLJ / EASY CHAIR / SESSEL / FAUTEUIL

2-SITS SOFFA / 2-SEATER SOFA / 2-SITZIG SOFA / SOFA 2 ASSIES

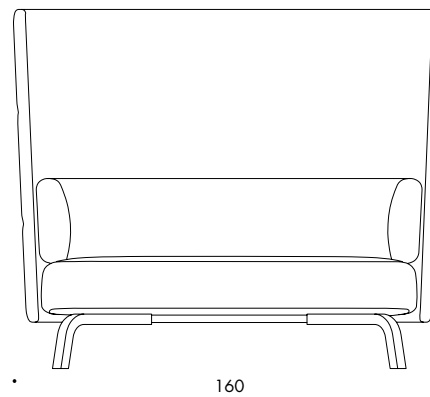
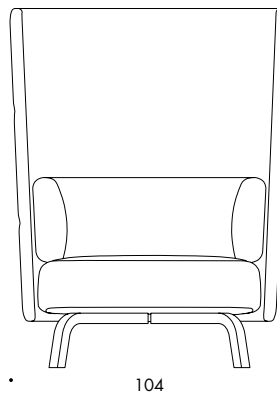
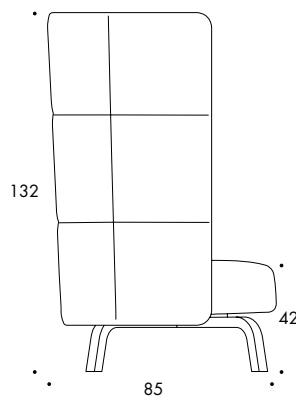
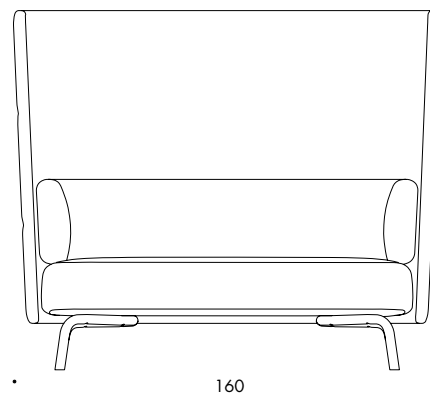
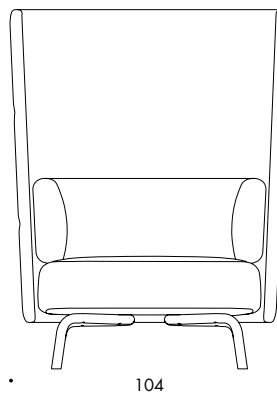
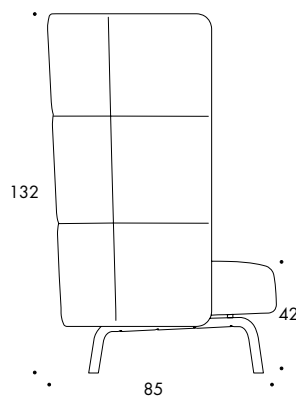
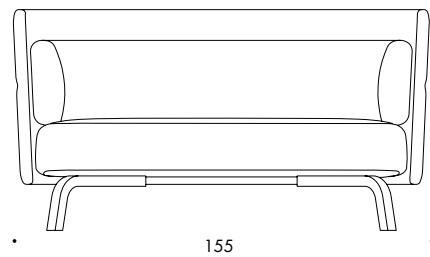
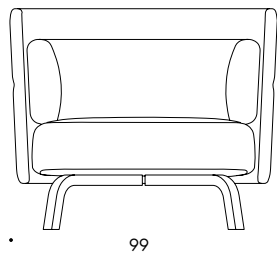
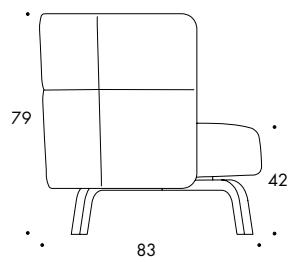
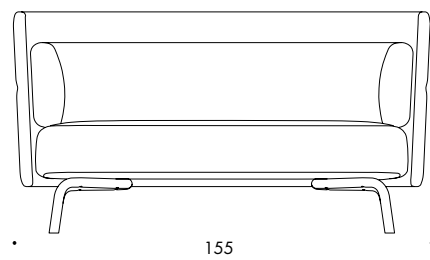
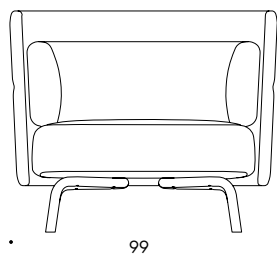
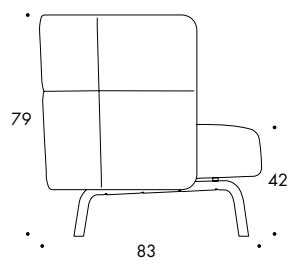

3-SITS SOFFA / 3-SEATER SOFA / 3-SITZIG SOFA / SOFA 3 ASSIES

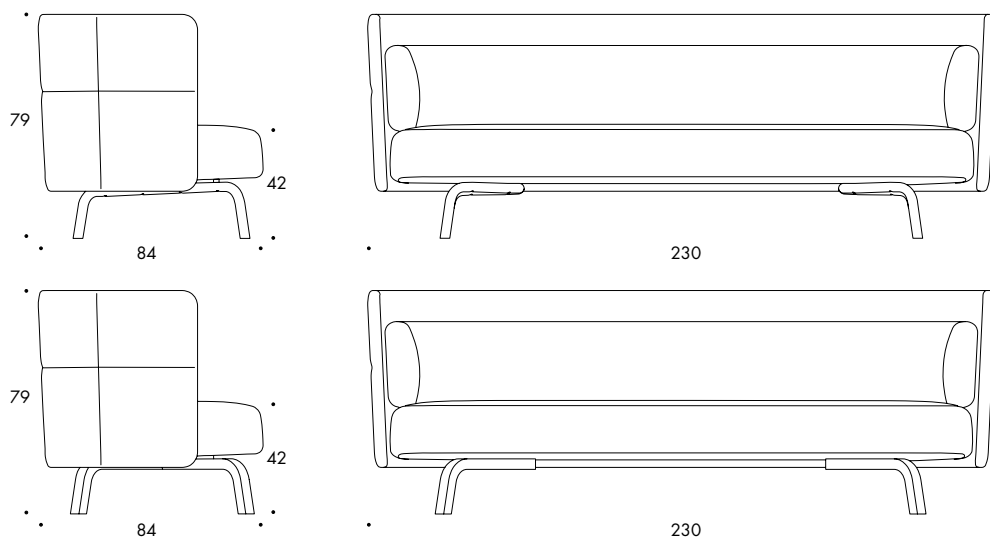

BÄNK / BENCH / SITZBANK / REPOSE-PIED

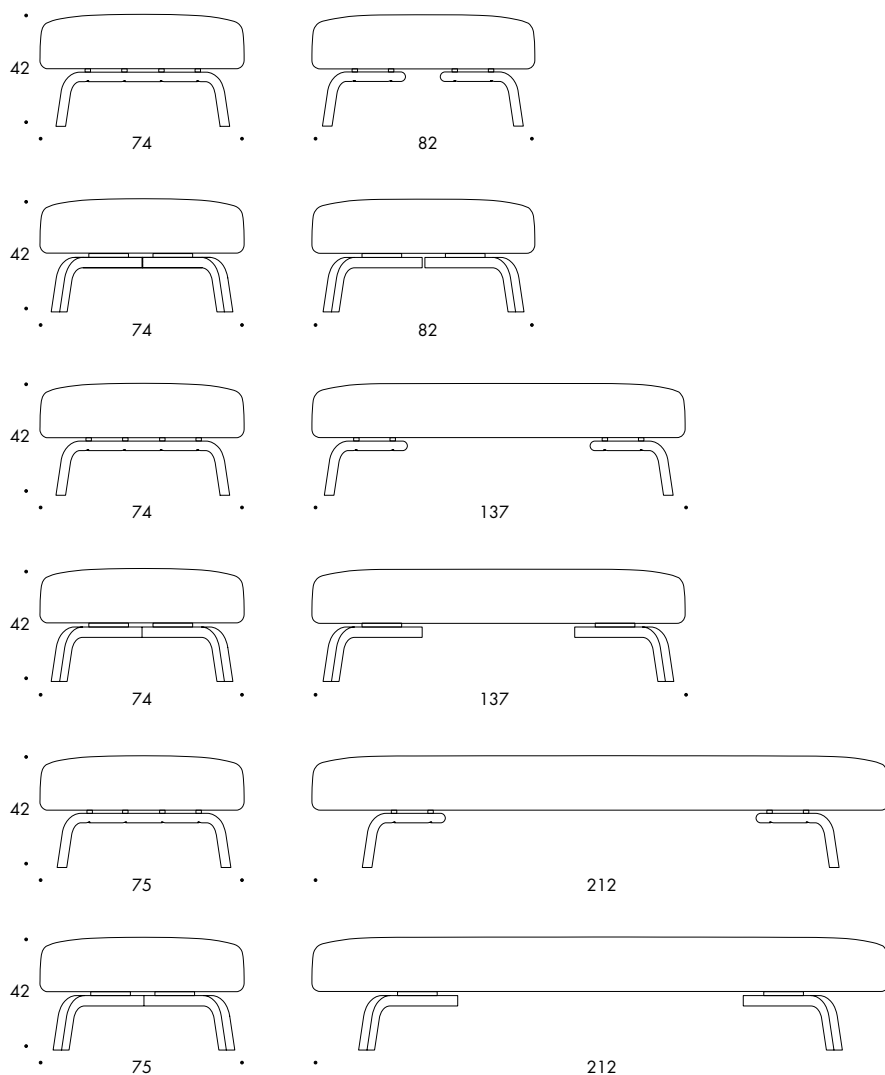

PORTUS

Ben av pulverlackerat eller förkromat Ø35mm stålror alt. ask natur eller bets. Glidfötter. Sitsstomme i massivt trä med gjutet kallsaum. Rygg i formpressat trä med stoppning av kallsaum inkl. kviltad baksida. Ryggkudde i gjutet kallsaum.

Vid tvåfärgad klädsel följer rygg-kudden sitsens färg.

OBS! Rygg i läder, konstläder eller mönstrat tyg erbjuds ej.

Sits och ryggkudde i dessa material mot förfrågan.

Vikt

Bänk: 1-sits 16.0 kg, 2-sits 24.0 kg, 3-sits 37.0 kg

Fåtölj: låg rygg 37.0 kg, hög rygg 50.0 kg

2-sits soffa: låg rygg 50.0 kg, hög rygg 72.0 kg

3-sits soffa: 68.0 kg

PORTUS

Legs of powder coated or chromium plated Ø35mm steel tubing alt. natural or stained ash. Glides. Seat frame of massive wood and molded high resilient polyurethane foam. Back of molded wood and high resilient polyurethane foam incl. quilting on the outside.

Back cushion of high resilient polyurethane foam. When upholstered in 2 colors the back cushion follows the color of the seat.

Note! Back in leather, imitation leather or patterned fabrics are not available. Seat and cushion in these materials on request.

Weight

Bench: 1-seater 16.0 kg, 2-seater 24.0 kg, 3-seater 37.0 kg

Easy chair: low back 37.0 kg, high back 50.0 kg

2-seater sofa: low back 50.0 kg, high back 72.0 kg

3-seater sofa: 68.0 kg

PORTUS

Gestell aus 35mm lackiertem oder verchromtem Stahlrohr. Alt Escheholzgestell Natur oder gebeizt. Gleiter. Sitzschale aus Formholz mit hochelastischem Polyether inkl. gesteppte Außenseite. Rückenkissen aus formgegossenem hochelastischem Polyether. Bei der zweifarbigen Polsterung folgt die Farbe des Rückenkissens die Farbe der Sitzfläche. **Achtung!** Leder, Kunstleder oder gemusterte Stoffe sind nicht verfügbar. Sitz und Rückenkissen auf Leder, Kunstleder oder gemusterte Stoffe auf Anfrage.

Gewicht

Sitzbank: 1-sitzig 16.0 kg, 2-sitzig 24.0 kg, 3-sitzig 37.0 kg

Sessel: niedrig 37.0 kg, hoch 50.0 kg

2-sitzig Sofa: niedrig 50.0 kg, hoch 72.0 kg

3-sitzig Sofa: 68.0 kg

PORTUS

Piètement en tube d'acier Ø35mm laqué époxy ou chromé, ou en frêne naturel ou teinté. Patins. Assise en bois massif et mousse de polyuréthane haute résilience moulée. Dossier en bois moulé et mousse de polyuréthane haute résilience, avec surpiqure sur le dossier. Coussin de dossier en mousse de polyuréthane haute résilience. Dans la version bi-couleur, le coussin de dossier est de la couleur de l'assise. **Attention:** Dossier impossible en cuir, vinyle ou tissus à motifs. Assise et coussin de dossier dans ces matériaux sur demande.

Poids

Repose-pied: 1 assise 16.0 kg, 2 assises 24.0 kg, 3 assises 37.0 kg

Fauteuil: bas 37.0 kg, haute 50.0 kg

Sofa 2 assises: bas 50.0 kg, haute 72.0 kg

Sofa 3 assises: 68.0 kg

PORTUS

BENCH / EASY CHAIR / SOFA

DESIGN JOHANNES FOERSOM & PETER HIORT-LORENZEN

Lammhults Möbel AB
Växjövägen 41, Box 26
SE-360 30 Lammhult
Sweden

CONTACT

+46 472 26 95 00 Phone

+46 472 26 05 70 Fax

info@lammhults.se

www.lammhults.se

LAMMHULTS

LAMMHULTS OCH MILJÖN

För att minska resursförbrukningen och påverkan på miljön arbetar Lammhults med tidlös design för långt produktliv. Vi utvecklar och producerar produkter från material som har minsta möjliga miljöpåverkan och inte resulterar i restprodukter utan kan material- eller energiåtervinnas. Vi strävar efter att förhindra utsläpp i alla våra processer och arbetar med att successivt reducera miljö- och klimatmässiga fotspår från vår produktionslinje. Lammhults är certifierat enligt ISO 14001 sedan 1998 och fortsätter att arbeta kontinuerligt med miljöfrågor för att försäkra minsta möjliga miljöpåverkan.

LAMMHULTS AND THE ENVIRONMENT

To reduce the consumption of resources and the environmental impact, Lammhults work with timeless designs for long product life. We develop and produce products from materials that have the least possible environmental impact and do not result in waste but can be recycled as materials or energy. We strive to prevent pollution in all of our processes and work to successively reduce the environmental and climate footprint of our production facilities. Lammhults is certified according to ISO 14001 since 1998 and continues to work with environmental issues to ensure the least possible environmental impact.