

# LAMMHULTS



QUICKLY

TABLE

DESIGN JOHANNES FOERSOM & PETER HIORT-LORENZEN

KVICKT GJORT. MED NÅGRA HANDGREPP BLIR  
SKIVAN ETT UPPFÄLLT ARBETS BORD.

Formgivare Johannes Foersom & Peter Hiort-Lorenzen

QUICKLY UNFOLDED. WITH ONLY A FEW  
CLICKS THE TABLE IS BACK TO WORK.

Designers Johannes Foersom & Peter Hiort-Lorenzen



Standard ben/ Standard leg



Standard ben/ Standard leg



Standard ben/ Standard leg





THE NORDIC ECO-LABLE APPLIES ON  
BASE: POWDERCOATED FRAME (NOT THE  
T-LEG), TABLETOP:MDF WITH LAMINATE,  
SIZES ACCORDING TO THE PRICELIST.

T-ben / T-leg



T-ben / T-leg



T-ben / T-leg





















## QUICKLY

Fällbara lackerade eller förkromade benbågar av Ø30 mm svetsade koniska stålrör. Fällbart T-bensstativ av lackerade eller förkromade Ø30 mm svetsade koniska stålrör finns som tillval Bordsskiva Flexible av 25 mm poppelplywood med högtrycks-laminat K2010 UN, vitgrå. Rak ljusgrå plastkantlist.  
För vissa storlekar finns följande bordsskivor som alternativ:  
- Premium, av 25 mm poppelplywood med högtryckslaminat K2010 UN, vitgrå. Fasad ljusgrå plastkantlist.  
- Basic, av 22 mm MDF med direktlaminat, NCS 1201-G91Y vitgrå alt askmönstrad. Matchande rak plastkantlist.

## Tillval

T-ben  
Hjul (gäller ej T-ben)  
Kopplingsbeslag  
Frontpanel  
¼-cirkelskivor (gäller ej bordsskiva Premium)  
Väggupphängningsbeslag  
Stolsupphängningsbeslag mot förfrågan  
Transportvagn

## QUICKLY

Foldable powder coated or chromium plated frame of Ø 30 mm welded conical steel tubing. Foldable T-leg frame of Ø 30 mm welded conical steel tubing available as option. Table top Flexible of 25 mm poplar plywood with high pressure laminate K2010 UN, white/grey. Light grey straight plastic edge. For some sizes the following table tops are available:  
- Premium, of 25 mm poplar plywood with high pressure laminate K2010 UN, white/grey. Light grey bevelled plastic edge.  
- Basic, of 22 mm MDF with melamine, NCS 1201-G91Y white/grey alt. ash decor. Matching straight plastic edge.

## Options

T-leg  
Wheels (not for T-leg)  
Linking device  
Modesty panel  
¼-circle top (not for table top Premium)  
Wall hanging device  
Chair hanging device on request  
Trolley

## QUICKLY

Klappbares, pulverbeschichtetes oder verchromtes Beingestell aus Ø30 mm geschweißtem, konischem Stahlrohr. Klappbares T-Beinbestell aus lackiertem oder verchromten Ø30 mm geschweißtem, konischem Stahlrohr optional wählbar. Tischplatte Flexible, 25 mm stark, aus Pappelsperholz mit Hochdrucklaminat K2010 UN, weiß/grau, hellgraue, gerade Kunststoffumleimer, Für einige Tischgrößen alternativ verfügbar:  
- Premium, Tischplatte aus Pappelsperholz mit Hochdrucklaminat K2010 UN, weiß/grau, hellgraue, Kunststoffumleimer mit Fase.  
- Basic: Tischplatte aus 22 mm MDF mit Direktlaminat, NCS 1201-G91Y, weiss/grau, alt. Aschelaminat. Passende gerade Kunststoffumleimer.

## Optionen

T-Beingestell  
Rollen (nicht für T-Beingestell)  
Verbindungsbeschlag  
Knieraumblende  
¼-Kreisplatte (nicht für Tischplatte Premium)  
Beschlag für Wandaufhängung  
Beschlag für Stuhlaufhängung auf Anfrage  
Transportwagen

## QUICKLY

Piètement pliant tube d'acier conique de Ø 30 mm laqué époxy ou chromé. En option piètement en T pliant. Plateau "Flexible" latté de peuplier épaisseur 25 mm finition stratifié gris blanc K2010 UN. Chant droit en ABS. Pour certaines dimensions les plateaux sont disponibles avec:  
- "Premium", Plateau latté de peuplier épaisseur 25 mm finition stratifié gris blanc K2010 UN. Chant biseauté en ABS.  
- "Basic", plateau médium épaisseur 22mm finition mélaminé gris blanc NCS 1201-G91Y ou frêne Chant droit ABS coloris coordonné.

## Options

Pieds en T  
Roulettes (sauf pied en T)  
Élément de liaison  
Voile de façade  
Plateau ¼ de cercle (sauf pour table "Premium")  
Crochet de suspension mural  
Structure de soutien pour chaise sous plateau  
Chariot



Premium



Basic, vitgrå direktlaminat /  
Basic, white/grey melamine



Basic, björkmönstrad direktlaminat /  
Basic, birch decor melamine



Basic, björkmönstrad direktlaminat /  
Basic, birch decor melamine



Flexible, laminat / Flexible, laminate

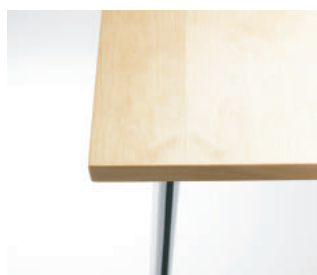

Flexible, björkfanér / Flexible, birch veneer



Flexible Flexible, ekfanér / Flexible, oak veneer



Flexible Flexible, ekfanér /  
Flexible, oak veneer



QUICKLY FOLDING TABLE

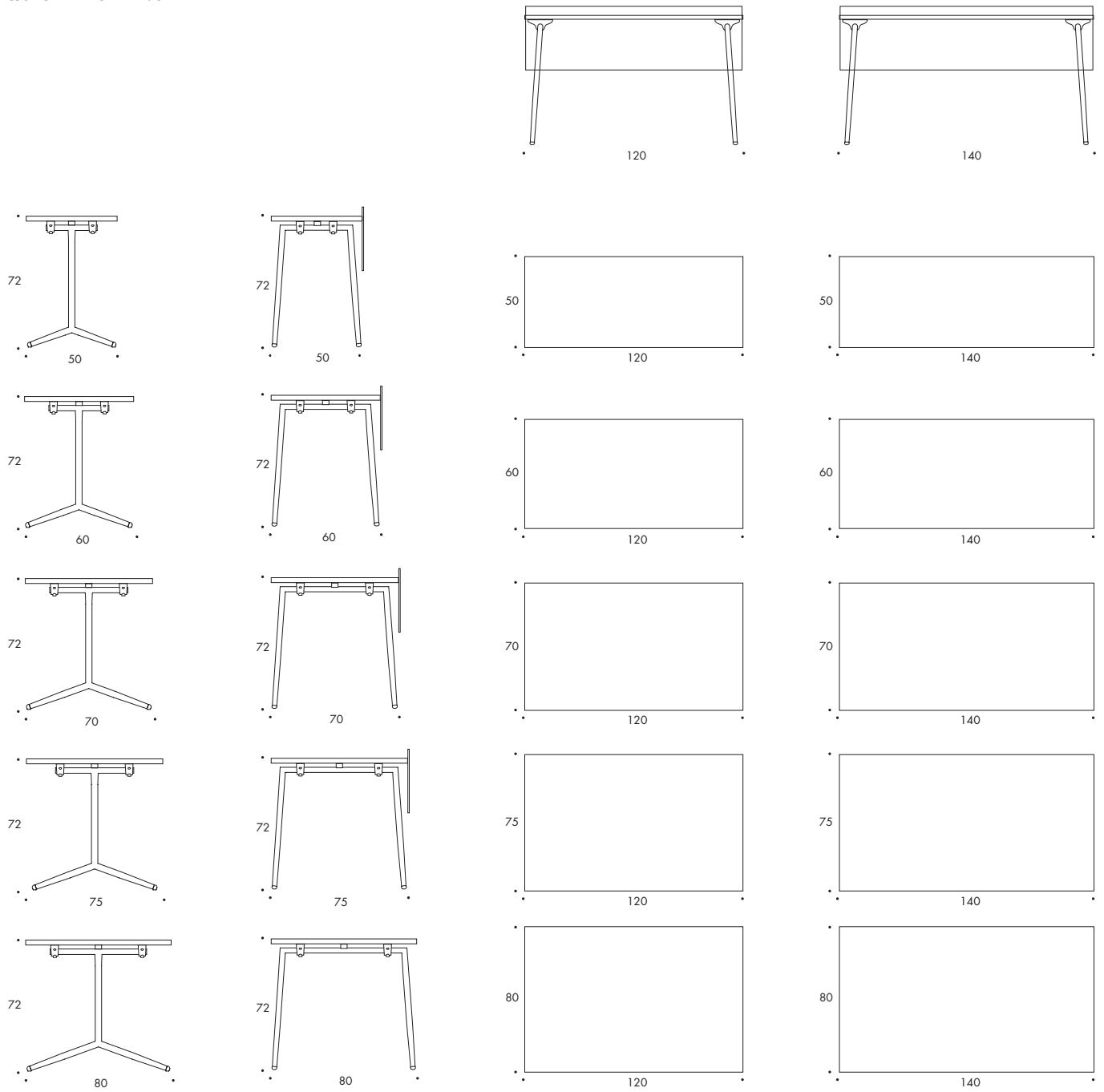
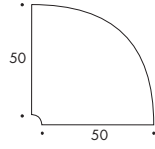

TABLE TOP SIZE OPTIONS (CM) & WEIGHT (KG)

Size	Flexible laminate	Flexible birch veneer	Flexible oak veneer	Premium	Basic white/grey & birch decor
120x50	12.3	11.9	11.9	-	-
120x60	14.4	13.6	13.6	14.4	19.2
120x70	16.3	15.3	-	16.3	23.5
120x75	17.1	16.1	-	-	-
120x80	-	17.4	-	-	-
140x50	13.8	-	-	-	-
140x60	15.9	14.9	14.9	14.4	21.5
140x70	18.0	16.8	16.8	18.0	23.5
140x75	18.9	17.7	17.7	-	-
140x80	-	18.6	-	-	-
180x60	18.8	17.6	-	-	-
180x70	21.4	19.9	-	-	-
180x75	22.5	20.1	-	22.5	-
180x80	-	22.1	-	-	-
¼-circle tops					
60x60	3.5	-	-	-	6.5
70x70	4.0	-	-	-	7.0



180



50

50

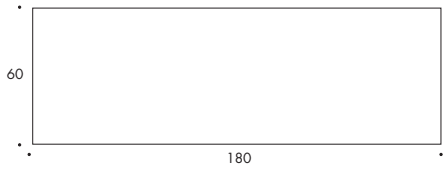

60

180

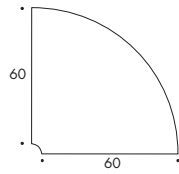

60

60

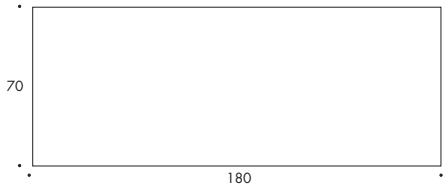

70

180

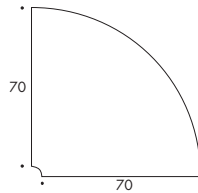

70

70

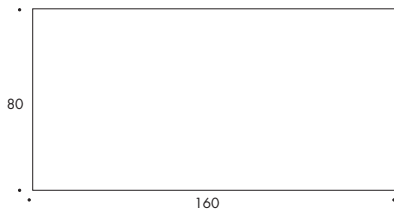

80

160

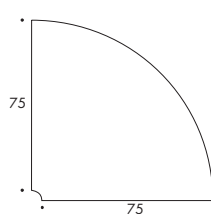

75

75

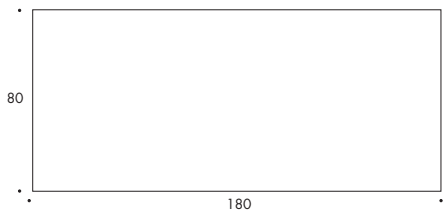

80

180

## QUICKLY TROLLEY

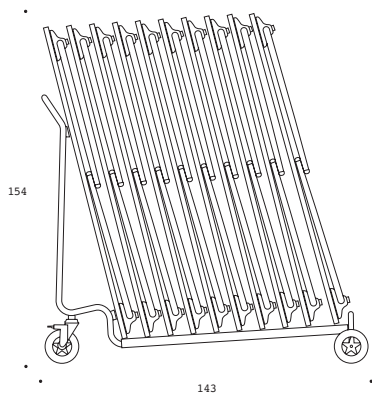

154

143



# QUICKLY

## TABLE

DESIGN JOHANNES FOERSOM & PETER HIORT-LORENZEN

Lammhults Möbel AB  
Växjövägen 41, Box 26  
SE-360 30 Lammhult  
Sweden

### CONTACT

+46 472 26 95 00 Phone  
+46 472 26 05 70 Fax  
info@lammhults.se

www.lammhults.se

# LAMMHULTS

## LAMMHULTS OCH MILJÖN

För att minska resursförbrukningen och påverkan på miljön arbetar Lammhults med tidlös design för långt produktliv. Vi utvecklar och producerar produkter från material som har minsta möjliga miljöpåverkan och inte resulterar i restprodukter utan kan material- eller energiåtervinnas. Vi strävar efter att förhindra utsläpp i alla våra processer och arbetar med att successivt reducera miljö- och klimatmässiga fotspår från vår produktionslinje. Lammhults är certifierat enligt ISO 14001 sedan 1998 och fortsätter att arbeta kontinuerligt med miljöfrågor för att försäkra minsta möjliga miljöpåverkan.

### OM SVANEN

Svanen är en av de främsta miljömärkningarna i världen. När du ser detta märke på varor eller tjänster betyder det att de har klarat hårda miljö- och klimatkrav. Kraven skärps kontinuerligt. Det betyder att produkter märkta med Svanen blir bättre och bättre ur miljösynpunkt. Läs mer på: [www.svanen.se](http://www.svanen.se)

## LAMMHULTS AND THE ENVIRONMENT

To reduce the consumption of resources and the environmental impact, Lammhults work with timeless designs for long product life. We develop and produce products from materials that have the least possible environmental impact and do not result in waste but can be recycled as materials or energy. We strive to prevent pollution in all of our processes and work to successively reduce the environmental and climate footprint of our production facilities. Lammhults is certified according to ISO 14001 since 1998 and continues to work with environmental issues to ensure the least possible environmental impact.

### ABOUT THE NORDIC ECO-LABEL

The Nordic Ecolabel is one of the toughest environmental labelling systems in the world. When you see this label on products or services it means that they have passed tough environmental and climate criteria. These criteria are also continually revised and improved making products labelled with the Nordic Ecolabel better and better for the environment. Read more at: [www.ecolabel.se](http://www.ecolabel.se)