



# MY DESK

design Sergio Lion

**FREZZA**<sup>®</sup>

CREATIVE FACTORY OFFICE, WORK IN PROGRESS SALONEUFFICIO 2008 COMPETITION In memory of Ing. Paolo Borsani, President of Assufficio.  
 PRODUCT PRIZE WORKING FURNITURE For MY DESK, extremely modular and flexible office furniture systems that allow different work areas to communicate and cooperate. The products also have a very simple air that makes them ideal for a young working environment.  
 UFFICIO FABBRICA CREATIVA, WORK IN PROGRESS CONCORSO SALONEUFFICIO 2008 en mémoire de l'ingénieur Paolo Borsani, président Assufficio.  
 PRIX PRODUIT AMENAGEMENT DE L'ESPACE TRAVAIL pour MY DESK, système d'aménagement pour bureau extrêmement modulaire et flexible qui permet la coexistence et le dialogue entre les différents usagers de l'espace de travail. Le produit donne également l'impression de bénéficier d'un excellent rapport qualité / prix, ce qui le rend particulièrement adapté à un contexte de travail jeune.



UFFICIO FABBRICA CREATIVA, WORK IN PROGRESS WETTBEWERB SALONEUFFICIO 2008 im Andenken an Ing. Paolo Borsani, Präsident der Assufficio.  
 PRODUKTPREIS BÜROEINRICHTUNGE für MY DESK, einem Büroeinrichtungssystem mit erweiterter Modularität und Flexibilität für die Koexistenz und den Dialog zwischen den verschiedenen Arbeitsplatznutzern. Das Produkt macht auch den Eindruck, wirtschaftlich vorteilhaft zu sein, wodurch es sich insbesondere für einen jugendlichen Kontext eignet.

OFICINA FÁBRICA CREATIVA, WORK IN PROGRESS CONCORSO SALONEUFFICIO 2008 en memoria del Ing. Paolo Borsani, presidente de Assufficio.  
 PREMIO PRODUCTO MUEBLES Y DECORACIÓN PARA EL AMBIENTE DE TRABAJO para MY DESK, sistema de muebles y decoración para oficina de alta modularidad y flexibilidad que permite la coexistencia y el diálogo entre las diversas personas que comparten el espacio de trabajo. El producto también da una impresión de economía que lo hace especialmente adecuado para un contexto de trabajo joven.

UFFICIO FABBRICA CREATIVA,  
 WORK IN PROGRESS  
 CONCORSO SALONEUFFICIO 2008  
 PREMIO PRODOTTO  
 ARREDI PER IL LAVORO

GOOD DESIGN AWARD  
 2008  
 THE CHICAGO ATHENAEUM  
 MUSEUM OF  
 ARCHITECTURE AND DESIGN



- 8 HABITAT EXECUTIVE
- 12 BRIEFING MEETING EXECUTIVE
- 18 HORIZONTAL DEVELOPEMENT
- 20 BRIEFING TALKING WORKING
- 24 EXECUTIVE FUNCTIONS
- 25 GENERAL OFFICE FUNCTIONS
- 26 VERTICAL DEVELOPEMENT
- 30 WELCOMING COLLABORATING
- 36 BRIDGE
- 38 TALKING EXECUTIVE
- 40 WORKING COLLABORATING
- 42 WORKING FOCUSING
- 44 WIRING LAYOUT
- 45 DETAILS OF THE STRUCTURE
- 50 WORKING COLLABORATING
- 60 MEETING TALKING
- 62 WELCOMING COLLABORATING
- 66 CAN BE ACCESSORISED
- 68 ACCESSORIES
- 70 SOUND DAMPING
- 78 VERTICAL MULTIPURPOSE, DIFFERENT USES
- 82 MOBILE SCREEN STORAGE UNITS
- 84 TO ORDER CUPBOARDS WITH WING DOORS
- 87 MODULAR UNITS
- 88 MATERIALS AND FINISHES
- 92 ELEMENTS

# MY DESK

Personalità  
nello spazio  
di lavoro

An office full of character  
Personnalité dans votre espace de travail  
Individualität am Arbeitsplatz  
Personalidad en tu espacio de trabajo

## MY DESK

sviluppa concetti fondamentali, ispirati alle nuove configurazioni dello spazio ufficio.

**MY DESK**  
Develops fundamental ideas, inspired by new configurations for the office.

- 1 Continuity between the workstation and technical compartment for linear compositions.
- 2 Approachable, modular top to form the three main types: worktable, meeting table and executive table.
- 3 Modular multifunction walls, designed as a backup for the various office activities and areas.

### MY DESK

Développe les concepts fondamentaux, qui s'inspirent des nouvelles configurations de l'espace bureau.

- 1 Continuité entre poste opérationnel et espace technique afin de créer des éléments linéaires en séquence.
- 2 Plateau assemblable et modulable pour former les trois typologies principales: plateau de travail, table de réunion et exécutive.
- 3 Pared polyvalente modulaire, conçue comme support pour les différentes activités ou zones.

### MY DESK

Entwickelt grundlegende Konzepte, inspiriert an den neuen Konfigurationen des Büroraums.

- 1 Kontinuität zwischen Büroarbeitsplatz und Technikmöbel zur Kreation linearer Elemente.
- 2 Modulare Anbauplatte zur Anordnung der drei wichtigsten Tischtypen: Bürotisch, Besprechungstisch und Direktionsstisch.
- 3 Modulare Mehrzweckwand zur Unterstützung der verschiedenen Tätigkeiten oder Bereiche.

### MY DESK

desarrolla conceptos fundamentales inspirados a las nuevas configuraciones del espacio de la oficina.

- 1 Continuidad entre puesto de trabajo operativo y compartimiento técnico para crear elementos lineales en secuencia.
- 2 Plano componible y modular para formar los tres tipos principales: mesa de trabajo, mesa de reunión y ejecutiva.
- 3 Pared polivalente modular, diseñada como soporte para las diversas actividades o áreas.

**1** Continuità tra postazione operativa e vano tecnico per creare elementi lineari in sequenza.

**2** Piano accostabile, e modulare a formare le tre tipologie prevalenti: tavolo di lavoro, tavolo riunione e executive.

**3** Parete polivalente modulare, progettata quale supporto per le diverse attività o aree.

## 1

Vano tecnico, contenitore e supporto per tavoli.

Technical compartment, storage unit and table support.

Espace technique, armoire et support pour tables.

Technikmöbel, Schrank und Tischhalterung. Compartimento técnico, contenedor y soporte para mesas.

## 2

Tavolo rettangolare struttura metallica.

Rectangular table with a metal structure.

Table rectangulaire structure métallique.

Rechteckiger Tisch mit Metalstruktur.

Mesa rectangular estructura metálica.

## 3

Controparete attrezzabile, polivalente.

Multipurpose, fitted false wall.

Contre-paroi pouvant être équipée, polyvalente.

Mehrzweck-Wandverkleidung für verschiedene Ausstattungen.

Contra-pared equipable, polivalente.





White — colour non-colour. A synthesis of all the colours it contains and summarises.

Symbol of purity and simplicity. Preferred colour by Mediterranean and modern architecture, where the refracted light emphasises its power and strength.

Colour of traditions and artistic vanguard. From the "White square on a white background" by Malevich to Mondrian's rectangles. The colour of contemporary Minimal art.

Of form and lack of form.

Of discreet presence, where the nearby colours, black and grey create a balance.

We imagine the settings for MY DESK as white, a new system of office furniture where the panels and finishes either coloured or in shades of grey create new quality work areas.

Le blanc. Couleur non couleur. Synthèse de toutes les couleurs qu'il contient et résume.

Symbole de pureté et de simplicité. Couleur de prédilection de l'architecture méditerranéenne et moderne, où la lumière émane sa puissance et sa force sur les surfaces.

Couleur de la tradition et de l'avant-garde picturale. Du "Carré blanc sur fond blanc" de Malevich aux rectangles de Mondrian. Couleur de l'Art minimaliste contemporain.

De la forme et de son absence.

De la présence discrète, près de laquelle les couleurs, le noir et le gris établissent un équilibre. Les espaces dans lesquels nous avons imaginé MY DESK sont blancs. Il s'agit d'un nouveau système opérationnel, dans lequel les panneaux et les finitions colorés et dans les tons gris, créent des zones afin de donner une nouvelle qualité au travail.

Weiß. Farbe und doch nicht Farbe. Synthese aller Farben — enthält und umfasst alle Farben. Symbol für Reinheit und Schlichtheit. Auserwählte Farbe der mediterranen und modernen Architektur, auf deren Oberfläche das Licht seine Kraft erst richtig zum Ausdruck bringt.

Farbe der traditionellen und avantgardistischen Malerei. Vom "Schwarzen Quadrat" Malewitsch bis hin zu den Rechtecken Mondrians.

Farbe des zeitgenössischen Minimalismus. Der Form und deren Abwesenheit.

Der zurückhaltenden Anwesenheit, neben der bunte Farben, Schwarz und Grau ein Gleichgewicht bilden. Weiß sind die Räume, in denen wir uns MY DESK vorgestellt haben. Das neue Büro-einrichtungssystem, dessen bunte und in Grautönen lieferbare Paneele und Ausführungen die Bereiche abgrenzen und für mehr Qualität am Arbeitsplatz sorgen.

El blanco. Color no color. Síntesis de todos los colores: los contiene y los resume.

Símbolo de la pureza y de la sencillez. El color elegido por la arquitectura mediterránea y moderna, en cuyas superficies la luz exalta su potencia y fuerza. Color de la tradición y de la vanguardia pictórica. Del 'Cuadrado blanco sobre fondo blanco' de Malevich a los rectángulos de Mondrian.

Color de la contemporánea Minimal art. De la forma y de su ausencia.

De la presencia discreta, al lado de la cual los colores y el negro y el gris establecen un equilibrio. Blancos son los ambientes en que hemos imaginado MY DESK, un nuevo sistema operativo, en que los paneles y los acabados, de colores y en los tonos de gris, crean áreas para dar una nueva calidad al trabajo.

Il bianco. Colore non colore. Sintesi di tutti i colori che li contiene e li riassume.

Simbolo della purezza e della semplicità.

Colore d'elezione dell'architettura mediterranea e moderna, nelle cui superfici la luce esalta la sua potenza e forza.

Colore della tradizione e dell'avanguardia pittorica. Dal 'Quadrato bianco su fondo bianco' di Malevich ai rettangoli di Mondrian.

Colore della contemporanea Minimal art.

Della forma e della sua assenza.

Della presenza discreta, vicino alla quale i colori e il nero e il grigio, stabiliscono un equilibrio.

Bianchi sono gli ambienti in cui abbiamo immaginato MY DESK, un nuovo sistema operativo, in cui i pannelli e le finiture, colorate e nelle tonalità di grigio, creano aree per dare una nuova qualità al lavoro.



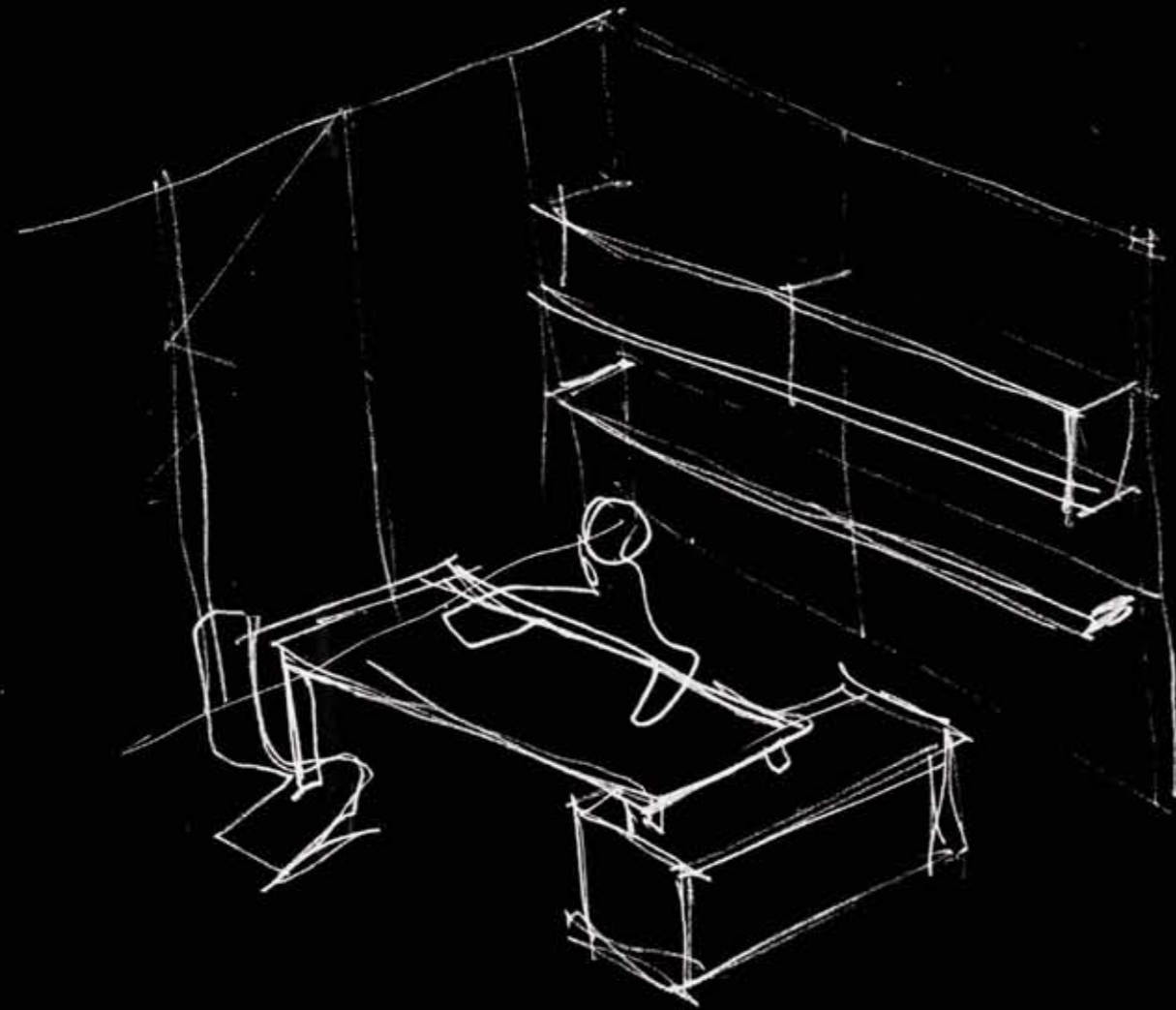

# L'HABITAT EXECUTIVE

Design  
Eleganza  
Privacy

EXECUTIVE HABITAT  
Design Elegance Privacy  
L'HABITAT EXECUTIVE  
Design Eleganza Privacy  
DAS DIREKTIONSBURO  
Design Eleganz Privatsphäre  
EL HABITAT EXECUTIVE  
Diseño Elegancia Privacidad



**DESIGN**

Nuove dimensioni per una scrivania che può diventare un tavolo riunioni.

**ELEGANZA**

Spazi armoniosi, con dettagli personalizzati in cui sentirsi bene in ogni ora del giorno.

**PRIVACY**

Soluzioni che consentono la concentrazione e la riservatezza, quando è necessaria, vicino al gruppo di lavoro.

**DESIGN**

New dimensions for a desk that becomes a meeting table.

**ELEGANCE**

Harmonious personalised areas where you feel good throughout the day.

**PRIVACY**

Solutions that allow you the right privacy to concentrate when needed, but still near to the rest of the team.

**DESIGN**

Nouvelles dimensions pour un bureau pouvant devenir une table de réunions.

**ELEGANCE**

Des espaces harmonieux, avec des détails personnalisés dans lesquels on se sent bien à toute heure de la journée.

**PRIVACY**

Des solutions permettant concentration et confidentialité, si nécessaire, près du groupe de travail.

**DESIGN**

Neue Dimensionen für einen Schreibtisch, der auch zum Besprechungstisch werden kann.

**ELEGANZ**

Harmonische Räume mit individuell gestalteten Details, zum tagtäglichen Wohlfühlen.

**PRIVATSPHÄRE**

Optimale Lösungen für Konzentration und eventuell nötige Vertraulichkeit trotz Teamnähe.

**DISEÑO**

Nuevas dimensiones para un escritorio que puede transformarse en una mesa de reuniones.

**ELEGANCIA**

Espacios armoniosos, con detalles personalizados, en los cuales uno puede sentirse a gusto en cualquier hora del día.

**PRIVACIDAD**

Soluciones que permiten la concentración y la discrecionalidad, cuando es necesaria, cerca del grupo de trabajo.



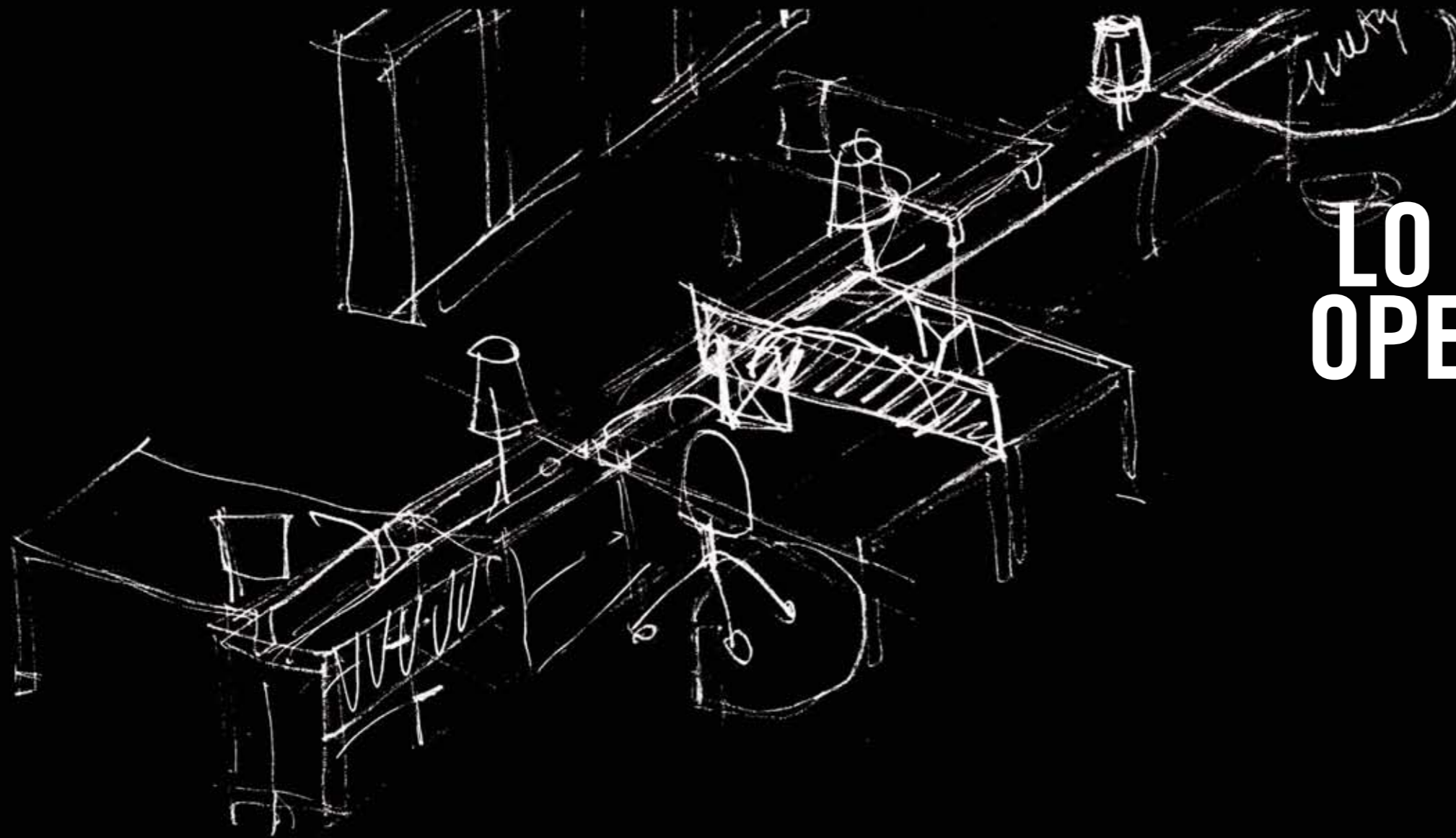

# LO SPAZIO OPERATIVO

Semplice  
Funzionale  
Organizzato

THE GENERAL OFFICE  
Simple Functional Organised  
L'ESPACE OPERATIONNEL  
Simple Fonctionnel Organisé  
DER BÜRRaum  
Einfach Funktionell Organisiert  
EL ESPACIO OPERATIVO  
Sencillo Funcional Organizado

**Postazione singola**  
Single workstation  
Poste individuel  
Einzelner Büroarbeitsplatz  
Puesto de trabajo individual

**Operativo multiplo con pannello frontale**  
Multiple desks with front panel  
Opérationnel multiple avec panneau frontal  
Mehrfach Büroarbeitsplatz mit Frontblende  
Operativo múltiple con panel frontal

**Operativi singoli in appoggio su cassettera-vano tecnico serigrafate**  
Single desks resting on the pedestal-technical compartment with screen-printed doors  
Opérationnels individuels en appui sur caisson-espace technique avec portes sérigraphiées  
Einzelne Arbeitsplätze aufliegend auf Technikmöbeln mit bedruckten Fronten  
Operativos individuales apoyados sobre cajonera-compartimiento técnico con puertas serigrafadas

**Tavolo riunione in appoggio su cassettera-vano tecnico**  
Meeting table resting on the pedestal-technical compartment  
Table de réunion en appui sur caisson-espace technique  
Besprechungstisch aufliegend auf Stützcontainer  
Mesa de reunión apoyada sobre cajonera-compartimiento técnico

**Postazione singola con allungo laterale e cassettera sospesa**  
Single workstation with side extension and suspended pedestal  
Poste individuel avec retour latéral et caisson suspendu  
Einzelner Arbeitsplatz mit Ansatzisch und Hängeunterbau  
Puesto de trabajo individual con extensión lateral y cajonera suspendida

**Parete attrezzata con ante serigrafate**  
Fitted wall with screen-printed doors  
Paroi équipée avec portes sérigraphiées  
Wandausstattung mit bedruckten Fronten  
Parete attrezzata con ante serigrafate

**Postazione singola**  
Single workstation  
Poste individuel  
Einzelner Büroarbeitsplatz  
Puesto de trabajo individual

**Operativo multiplo con pannello frontale**  
Multiple desks with front panel  
Opérationnel multiple avec panneau frontal  
Mehrfach-Büroarbeitsplatz mit Frontblende  
Operativo múltiple con panel frontal

**Operativi singoli in appoggio su cassettera-vano tecnico con ante serigrafate**  
Single desks resting on the pedestal-technical compartment with screen-printed doors  
Opérationnels individuels en appui sur caisson-espace technique avec portes sérigraphiées  
Einzelne Arbeitsplätze aufliegend auf Technikmöbeln mit bedruckten Fronten  
Operativos individuales apoyados sobre cajonera-compartimiento técnico con puertas serigrafadas

**Tavolo riunione in appoggio su cassettera-vano tecnico**  
Meeting table resting on the pedestal-technical compartment  
Table de réunion en appui sur caisson-espace technique  
Besprechungstisch aufliegend auf Stützcontainer  
Mesa de reunión apoyada sobre cajonera-compartimiento técnico

**Postazione singola con allungo laterale e cassettera sospesa**  
Single workstation with side extension and suspended pedestal  
Poste individuel avec retour latéral et caisson suspendu  
Einzelner Arbeitsplatz mit Ansatzisch und Hängeunterbau  
Puesto de trabajo individual con extensión lateral y cajonera suspendida

**Parete attrezzata con ante serigrafate**  
Fitted wall with screen-printed doors  
Paroi équipée avec portes sérigraphiées  
Wandausstattung mit bedruckten Fronten  
Parete attrezzata con ante serigrafate

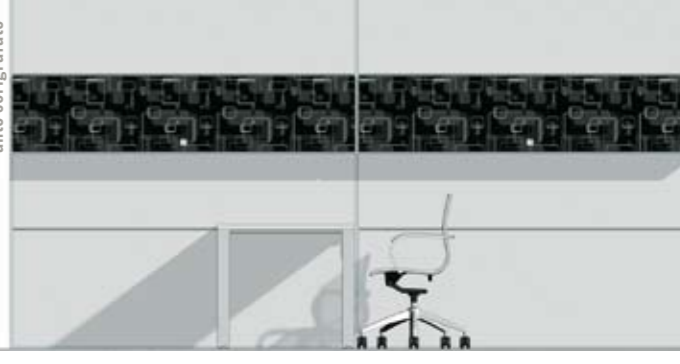
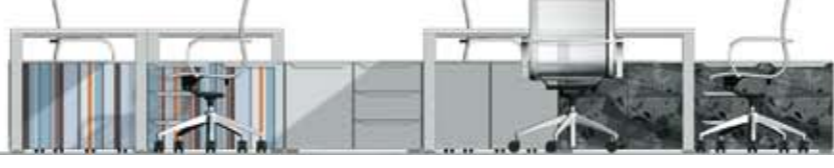
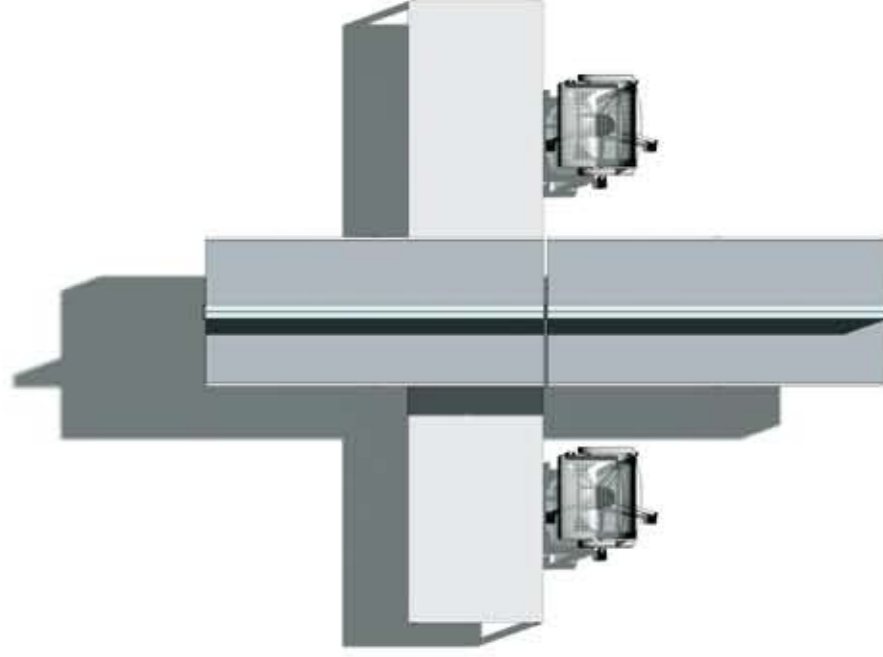
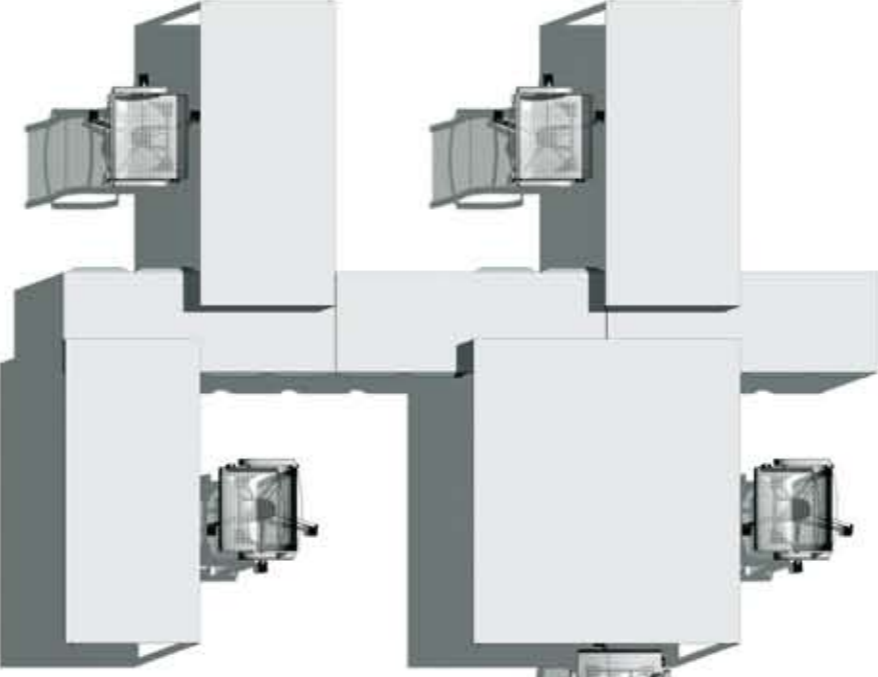





Moduli aggregabili linearmente,  
per **soluzioni condivise**  
con area facility manager.

Units that can be matched in a line,  
for work areas that are shared with  
the facility manager areas.  
Modules assemblables de manière  
linéaire, pour des solutions partagées  
avec zone facility manager.  
Linear anreihbare Module, für  
Teamlösungen mit Area Facility  
Manager.  
Módulos agregables linealmente,  
para soluciones compartidas con  
area facility manager.







Pannello schermo montato su  
struttura condivisa con gamba monolitica

Screen panel mounted on a shared structure with a monolithic leg  
 Panneau écran monté sur structure partagée avec pied monolithique  
**Blende, montiert auf geteilter Struktur mit massivem Bein**  
 Panel pantalla montado en estructura compartida con pata de una sola pieza



## MY DESK è un sistema che amplia il concetto di modularità e aggregabilità nello spazio ufficio

My Desk extends the idea of matching and modules in the office.  
 My desk est un système qui amplifie le concept de modularité et d'associabilité dans l'espace bureau.  
 My Desk erweitert das Konzept der Modularität und Anbaufähigkeit im Büroraum.  
 My desk es un sistema que amplia el concepto de modularidad y agregabilidad en el espacio de la oficina.

**Postazione singola**  
 Single workstation  
 Poste individuel  
 Einzelner Büroarbeitsplatz  
 Puesto de trabajo individual

**Postazione singola in appoggio**  
 Single workstation  
 Poste individuel en appui  
 Einzelner Büroarbeitsplatz aufliegend  
 Puesto de trabajo individual apoyado

**Postazione singola e bridge**  
 Single workstation and bridge  
 Poste individuel en appui et bridge  
 Einzelner Büroarbeitsplatz und Brücke  
 Puesto de trabajo individual y bridge

**Contentori modulari con piani sagomati**  
 Modular storage units with shaped tops  
 Meubles modulables avec des plateaux galbés  
 Modularen Schränken definierten und individualisierten den Arbeitsbereich  
 Contenedores modulares y equipados con sobrees de mesas compactos

**Parete con postazioni singole con piano laterale in appoggio sulla parete.**  
 Wall with single workstations with side top resting on the wall.  
 Paroi avec postes individuels avec plateau latéral en appui sur la paroi.  
 Wand mit einzelnen Büroarbeitsplätzen mit seitlicher Platte, aufliegend an der Wand.  
 Pared con puestos de trabajo individuales con plano lateral apoyado en la pared.

1

**Gamba metallica**  
 Metal leg  
 Pied métallique  
 Metallbein  
 Pata metálica

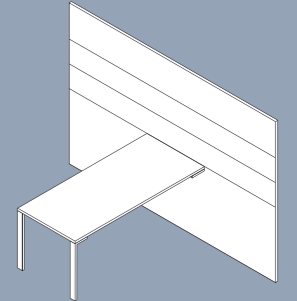
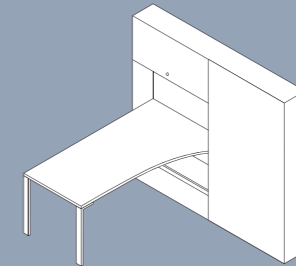
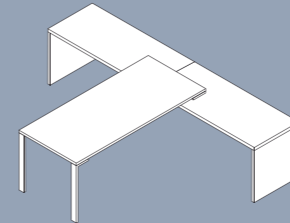
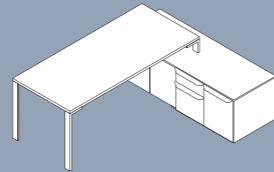
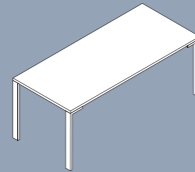

2

**Gamba monolitica**  
 Monolithic leg  
 Pied monolithique  
 Massives Bein  
 Pata de una sola pieza

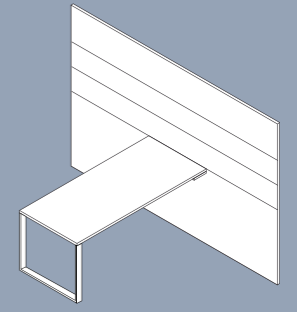
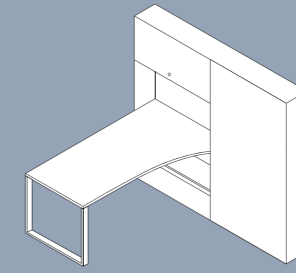
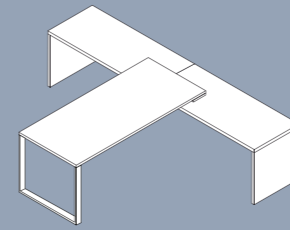
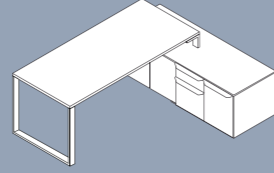
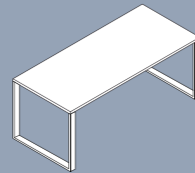

3

**Gamba pannellata**  
 Panelled leg  
 Pied panneau  
 Wangenstruktur  
 Pata con panelas

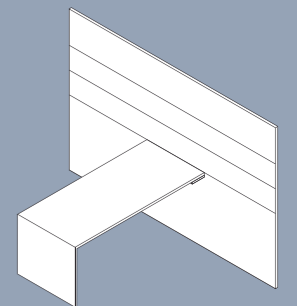
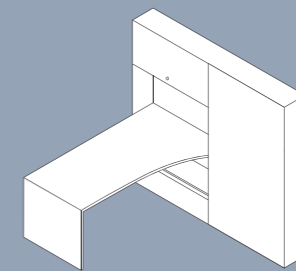
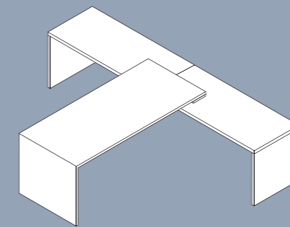
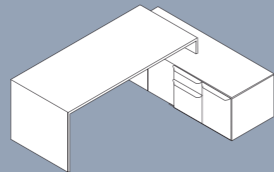
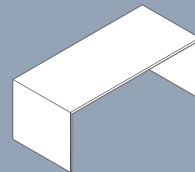

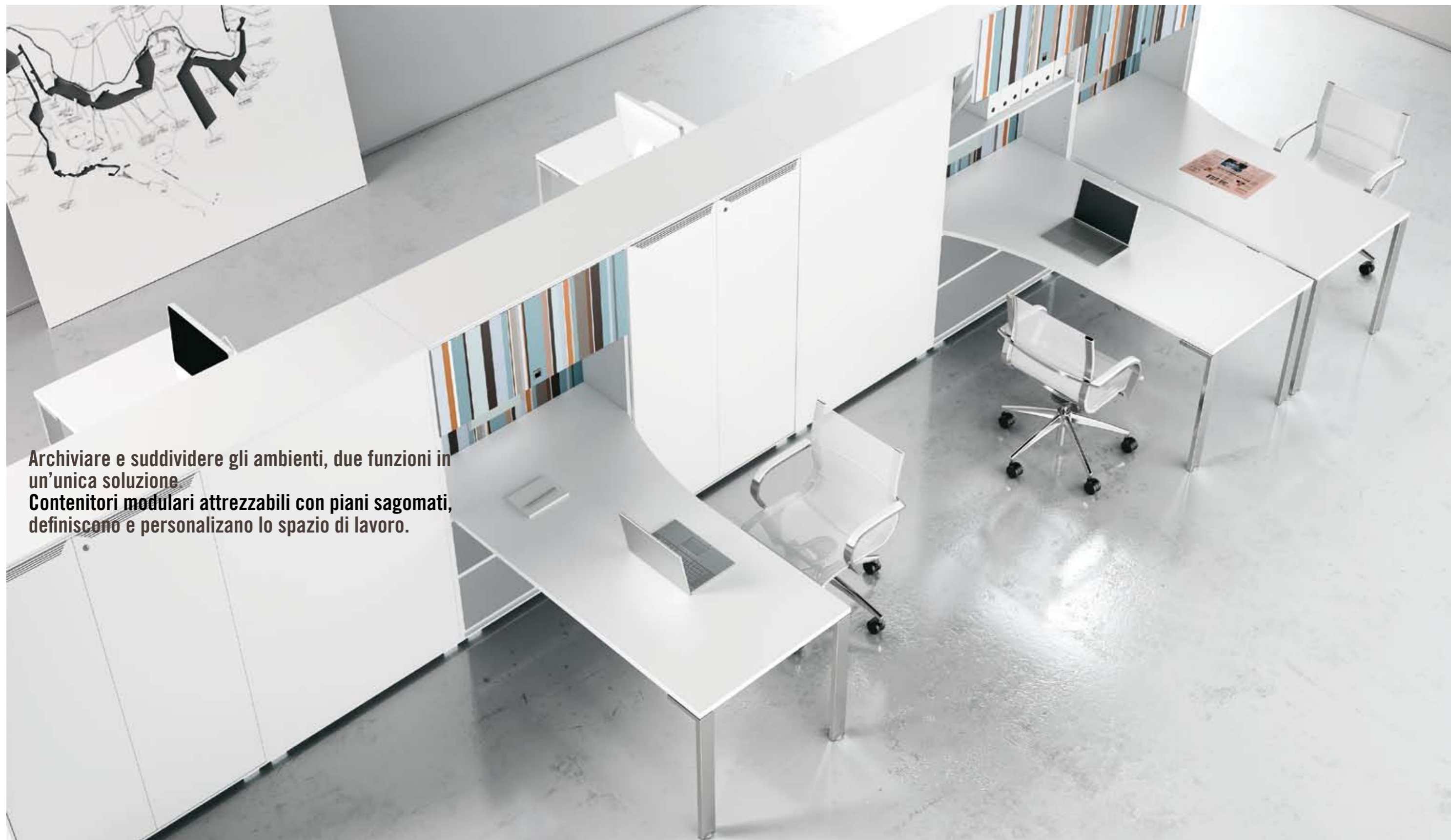

Archiviare e suddividere gli ambienti, due funzioni in un'unica soluzione  
Contenitori modulari attrezzabili con piani sagomati, definiscono e personalizzano lo spazio di lavoro.



Moduli aggregabili linearmente, per  
soluzioni condivise con area facility  
manager.  
Archiver et diviser les espaces, une  
unique solution pour deux fonctions.  
Meubles modulables, pouvant être équi-  
pés avec des plateaux galbés, délimitent  
et personnalisent les espaces de travail  
Freiformarbeitsplätze integriert  
mit modularen Schränken  
definieren und individualisieren  
den Arbeitsbereich  
Moduli aggregabili linearmente, per  
soluzioni condivise con area facility  
manager.





Estetica e diversificazione dello spazio.  
La filosofia MY DESK si esprime anche attraverso i dettagli: parete con serigrafie, contenitori con ante in vetro, area break.

Attractive diversified spaces.  
MY DESK philosophy is also expressed in the details: screen-printed walls, storage units with glass doors, break areas.

Esthétique et diversification de l'espace.  
La philosophie MY DESK s'exprime également à travers les détails : pari avec sérigraphies, armoires avec portes vitrées, zone break.

Ästhetik und Raumteilung.  
Die Philosophie von MY DESK kommt auch über die Details zum Ausdruck: Wand mit Aufdruck, Schränke mit Glasüren, Pausenecke.

Estética y diversificación del espacio.  
La filosofía MY DESK se expresa también a través de los detalles: pared con serigrafías, contenedores con puertas de vidrio, área break.

Due postazioni lavoro, composte da scrivanie accoppiate, su una struttura a ponte con cassetiera sospesa.



Deux postes de travail, composés de bureaux couplés, sur une structure à pont avec caisson suspendu.  
 Doppelarbeitsplatz auflegend auf einer Brücke mit Hängeunterbau.  
 Dos puestos de trabajo, compuestos por escritorios acoplados, sobre una estructura de puente con cajonera suspendida.





Struttura accessoriata per l'elettificazione, organizza la raccolta e la distribuzione dei cavi, nascondendoli alla vista tramite apposite guide in pvc.

Filleter structure that can be fitted for wiring, to contain and carry the leads along hidden PVC ducts.

Structure carénée équipable pour l'électrification, organise l'assemblage et la distribution des câbles en les dissimulant via des goulotte spéciales en pvc.

Struktur mit Aufnahmefähigkeit der Elektrokabel. Organisiert die Sammlung und Neuverteilung der Kabel und verdeckt diese durch eigene PVC-Profile.

Estructura carenada equipable con accesorios para la electrificación, organiza la recogida y la distribución de los cables, escondiéndolos por medio de específicas guías en PVC.

Scrivanie accoppiate, su una struttura a ponte con cassettiere sospese.

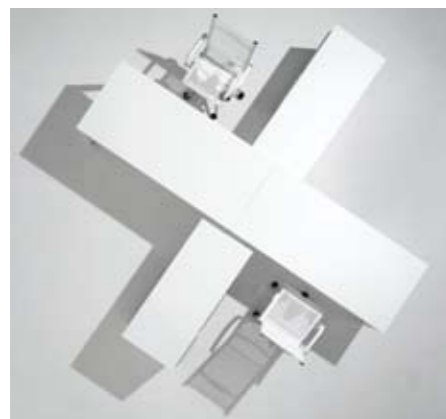

Coupled desks, fitted on a bridge structure with suspended pedestals.  
Bureaux couplés, sur une structure à pont avec caissons suspendus.  
Doppelarbeitsplatz aufliegend auf zwei Brücken mit Hängeunterbauten.  
Escritorios acoplados, sobre una estructura de puente con cajoneras suspendidas.







Tavoli accostabili doppi, utilizzano un ponte centrale che distribuisce e organizza lo spazio.

Double desks that are joined by a central bridge unit for practical organisation of the space.  
Tables doubles assemblables, elles utilisent un pont central qui distribue et organise l'espace.  
Aneinander gereihete Zwillingstische mit mittlerer Brückenstruktur zur Aufteilung und Organisation des Raums.  
Mesas componibles dobles, utilizan un puente central que distribuye y organiza el espacio.

Parete protagonista per la sua valenza estetica. Organizza l'archiviazione con elementi sospesi senza invadere lo spazio.



An important attractive wall that can be fitted with suspended space-saving filing units.

Pareti protagoniste grâce à sa valeur esthétique. Organise l'archivage avec des éléments suspendus sans envahir l'espace.

Die Wand als Protagonist - wegen ihres Aussehens. Organisiert die Archivierung mit Hängeschränken, ohne sich des Raums zu bemächtigen.

Pared protagonista por su valor estético. Organiza el archivado con elementos suspendidos sin invadir el espacio.





Materiali a caratterizzare spazi di qualità.  
Postazioni singole e tavolo riunioni, con piani  
in essenza, parete attrezzata personalizzata da  
serigrafie e piani in vetro.



Precious materials for quality spaces.  
single workstations and meeting tables  
with wood tops, fitted walls personalised  
with screen-printed patterns and glass  
tops.

**Matériaux qui caractérisent les espaces  
de qualité. Postes individuels et table  
de réunions, avec plateaux en essence,  
paroi équipée et personnalisée avec des  
sérigraphies et plateaux en verre.**

**Werkstoffe, die für Qualitätseinrichtun-  
gen sprechen. Einzelne Büroarbeitsplätze  
und Besprechungstische mit Holzplatten,  
Wandausstattungen mit Aufdrucken und  
Glasplatten.**

Materiales que caracterizan espacios de  
calidad. Puestos de trabajo individuales  
y mesa de reuniones, con planos de  
madera, pared equipada personalizada  
por serigrafías y planos de vidrio.



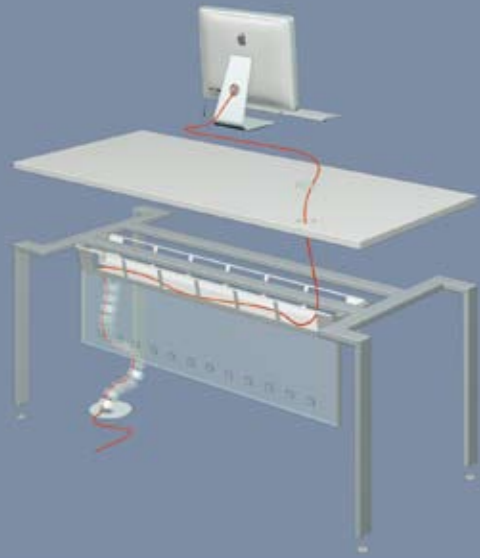

Struttura in gamba metallica con vertebra snodabile in pvc e canalina passacavi.  
 Structure with metal leg with jointed PVC spine and cable duct.  
 Structure en pied métallique avec carter articulé en pvc et goulotte passe-câbles.  
 Struktur mit Metallbein mit Gelenks-Kabelführung aus PVC und Kabelkanal.  
 Estructura en pata metálica con vértebra articulada en PVC y canaleta pasacables.

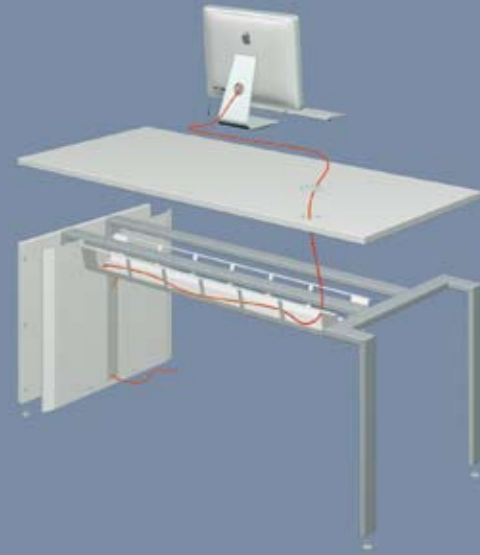

Struttura mista in gamba metallica e gamba pannellata con carter e canalina passacavi.  
 Mixed structure with metal leg and panelled leg, with carter and cable duct  
 Structure mixte en pied métallique et pied avec panneau avec carter et goulotte passe-câbles.  
 Gemischte Struktur: Metallbein und Wange mit Kabelabverkleidung, plus Kabelkanal  
 Estructura mixta en pata metálica y pata con paneles con cárter y canaleta pasacables.

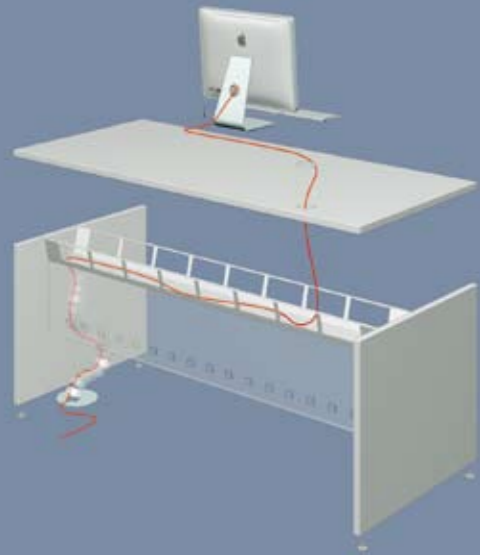

Struttura in gamba pannellata con vertebra snodabile in pvc e canalina passacavi.  
 Structure with panelled leg, jointed PVC spine and cable duct.  
 Structure en pied métallique avec carter articulé en pvc et goulotte passe-câbles.  
 Wangenstruktur mit Gelenks-Kabelführung aus PVC und Kabelkanal  
 Estructura en pata con paneles con vértebra articulada en PVC y canaleta pasacables.

Rectangular section tubular structure with height adjustable foot. Various finishes are available for the metal structure: painted, aluminium and chrome.  
 La goulotte, sous le plateau, est utilisée comme structure du bureau et d'élément de fixation au panneau. La distribution et l'accès aux câbles, sont possible par les trous de la goulotte.  
 Der Unterbau-Kabelkanal hat eine konstruktive Funktion als Wangenträger. Seine Netzstruktur vereinfacht erheblich den Zugang zu den Kabeln.  
 Estructura en tubular de sección rectangular con pie regulable en altura. Varios tipos de acabado de la estructura metálica: barnizada, aluminio y cromada.



La canalizzazione sottopiano ha una funzione strutturale e di sostegno al pannello. La distribuzione e l'accessibilità dei cavi, sono rese possibili con praticità attraverso i fori della struttura reticolare.

# UN NUOVO LINGUAGGIO VISIVO

Tre  
declinazioni  
decorative:  
**Square**  
Japan  
Stripes

A NEW VISUAL LANGUAGE  
Three different decorations:  
Square Japan Stripes  
UN NOUVEAU LANGAGE VISUEL  
Trois déclinaisons de décoration:  
Square Japan Stripes  
EIN NEUES VISUELLES  
AUSDRUCKSMITTEL  
Drei Dekorlinien:  
Square Japan Stripes  
UN NUEVO LENGUAJE VISUAL  
Tres conjugaciones decorativas:  
Square Japan Stripes

Typical Japanese style flowers and irregular geometric patterns.  
**Motifs floraux et formes géométriques irrégulières, ils s'inspirent de la tradition graphique japonaise.**  
Blumenmotive und unregelmäßige geometrische Formen ganz nach der Tradition der japanischen Grafik.  
**Motivos florales y formas geométricas irregulares, retoman la tradición gráfica japonesa.**

# JAPAN

Motivi floreali e forme geometriche irregolari, riprendono la tradizione grafica giapponese.





Bright screens in satin finish glass to divide the work area but leave freedom to communicate.  
 Ecrans lumineux en verre satiné, ils divisent les postes de travail, sans exclure la possibilité de communiquer.  
 Helle Blenden aus satiniertem Glas teilen die Arbeitsplätze, ohne die Kommunikation zu unterbinden.  
 Luminosas pantallas de vidrio satinado dividen puestos de trabajo, sin afectar la posibilidad de comunicación.



Luminosi schermi in vetro satinato, dividono postazioni di lavoro, senza precludere la possibilità di comunicare.

Pastel coloured vertical bars that are available in all the finishes provided by the MY DESK programme.

Barres colorées en vertical, aux teintes pastelées que l'on peut assortir à toutes les finitions prévues par le programme MY DESK.

Bunte senkrechte Streifen in Pastellfarben, die zu allen Ausführungen des Programms MY DESK passen.

Barras de colores en vertical con colores pastel que se pueden combinar con todos los acabados previstos por el programa MYDESK.

# STRIPES

Barre colorate in verticale dalle tinte pastello accostabili a tutte le finiture previste dal programma MY DESK.

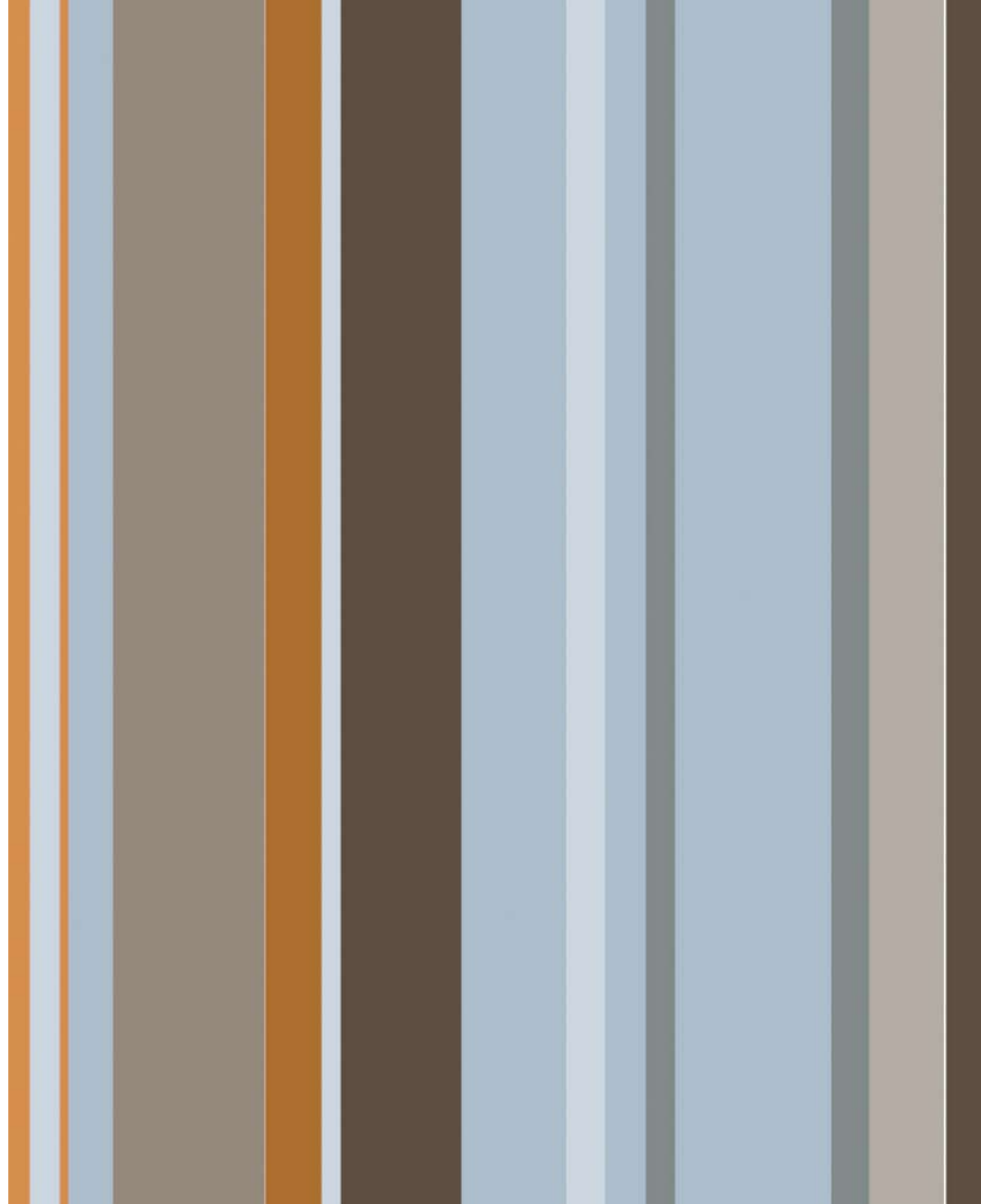

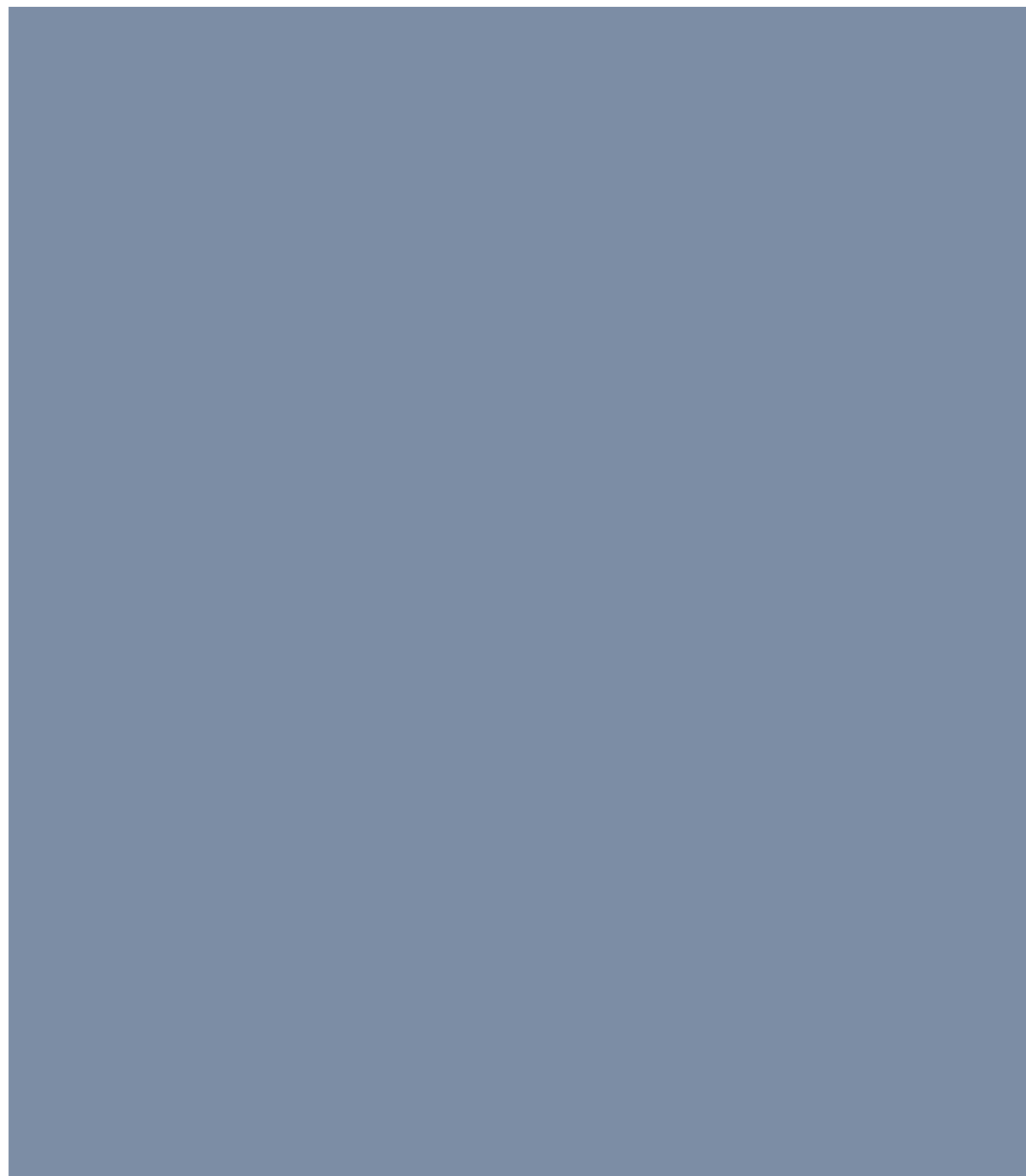



Pannello schermo montato su struttura condivisa dotata di vaschetta per l'alloggiamento dei cavi e accessori.

Screen panel mounted on a shared structure with basket for wiring and accessories  
 Panneau écran monte sur une structure partagée, équipée d'un bac pour le logement des câbles et des accessoires.  
**Blende auf geteilter struktur mit aufnahme für kabel und zubehör.**  
 Panel pantalla montado sobre estructura compartida dotada de bandeja para el alojamiento de cables y accesorios.



Square modules in different sizes and shades of grey, for a lightweight, deep finishing panel.

Les modules carrés de différentes dimensions et avec une tonalité de gris, donnent légèreté et profondeur au panneau de finition.

Quadratische Module mit unterschiedlichen Abmessungen und Grautönen, verleihen dem Panel Leichtigkeit und Tiefe.

Módulos cuadrados, con diversas dimensiones y tonalidades de gris, dan ligereza y profundidad al panel de acabado.

# SQUARE

Moduli quadrati, dalle diverse dimensioni e tonalità di grigio, danno leggerezza e profondità al pannello di finitura.

Essenziale nelle linee, il tavolo riunioni, segna la centralità del luogo di condivisione nella dinamica del lavoro d'ufficio.



The essential lines of the meeting table highlight its focal point within the office. Avec ses lignes essentielles, la table de réunions marque la position centrale de la dynamique du travail de bureau.

**Besprechungstische mit essenzieller Linienführung als Zeichen der zentralen Bedeutung des Versammlungsraums innerhalb der Bürodynamik.**

Esencial en las líneas, la mesa de reuniones, subraya la centralidad del lugar de división en la dinámica del trabajo de oficina.



By joining the desks together just a single bearing structure is required, doing away with the double legs.

**Leur assemblage permet d'exclure les doubles pieds en utilisant une seule structure portante.**

Für linearen Verkettungen bieten sich durchgehende Gestelle - keine doppelten Beine mehr.

La posibilidad de acercar los escritorios permite eliminar dobles patas usando una única estructura portante.



L'accostabilità tra scrivanie permette di escludere doppie gambe usando un'unica struttura portante.





La parete MY DESK si può integrare, con diversi accessori a varie altezze: il pensile, la mensola, il porta riviste e libri, ....

The MY DESK wall can be fitted with various accessories at different heights: hanging unit, shelf, magazine and book rack  
La paroi MY DESK peut s'intégrer, avec différents accessoires à des hauteurs différentes: l'élément haut, l'étagère, le porte-revues/livres, ....  
Die Wand MY DESK kann mit verschiedenen Accessoires in unterschiedlichen Höhen ausgestattet werden: Hängeschränk, Bord, Zeitungs- und Buchablage ...  
Organizar el propio puesto de trabajo con accesorios resistentes: bandejas aplicables sobre los paneles de pantalla (screen), porta-CDs, memory, porta-documentos en aluminio plegado





Organizzare la propria postazione di lavoro con accessori resistenti: vaschette applicabili sui pannelli screen, porta CD, memory, portadocumenti, in alluminio piegato



A collection of strong accessories to organise your workstation: baskets that can be hung on the screen panels, CD holders, CPU holder and document tray in shaped aluminium.

Organiser son poste de travail avec des accessoires résistants : bacs applicables sur des panneaux écrans, porte-CD, memory, porte-documents, en aluminium plié.

Organisation am Arbeitsplatz mit strapazfähigen Accessoirs: Verschiedene Ablagen für CDs, Notizblock, Dokumente, zur Berestigung an der Sichtblende, aus gebogenem Aluminium.

Organizar el propio puesto de trabajo con accesorios resistentes: bandejas aplicables sobre los paneles de pantalla (screen), porta-CDs, memory, porta-documentos, en aluminio plegado.



La controparete non è solo un versatile supporto funzionale ed estetico, ma un'efficace membrana fonoassorbente tra i vari ambienti.

The false wall is not only a versatile, functional and attractive support, but also an effective sound damper between the work areas.

La contre-paroi n'est pas seulement un support universel fonctionnel et esthétique, mais est également une membrane anti-bruit efficace entre les différents espaces.

Die Wandverkleidung erfüllt nicht nur vielseitige funktionelle und ästhetische Anforderungen, sondern ist auch ein wirksamer Schalldämpfer zwischen den Räumen.

La contra-pared no sólo es un soporte versátil funcional y elegante, sino también una eficaz membrana fonoabsorbente entre los varios ambientes.



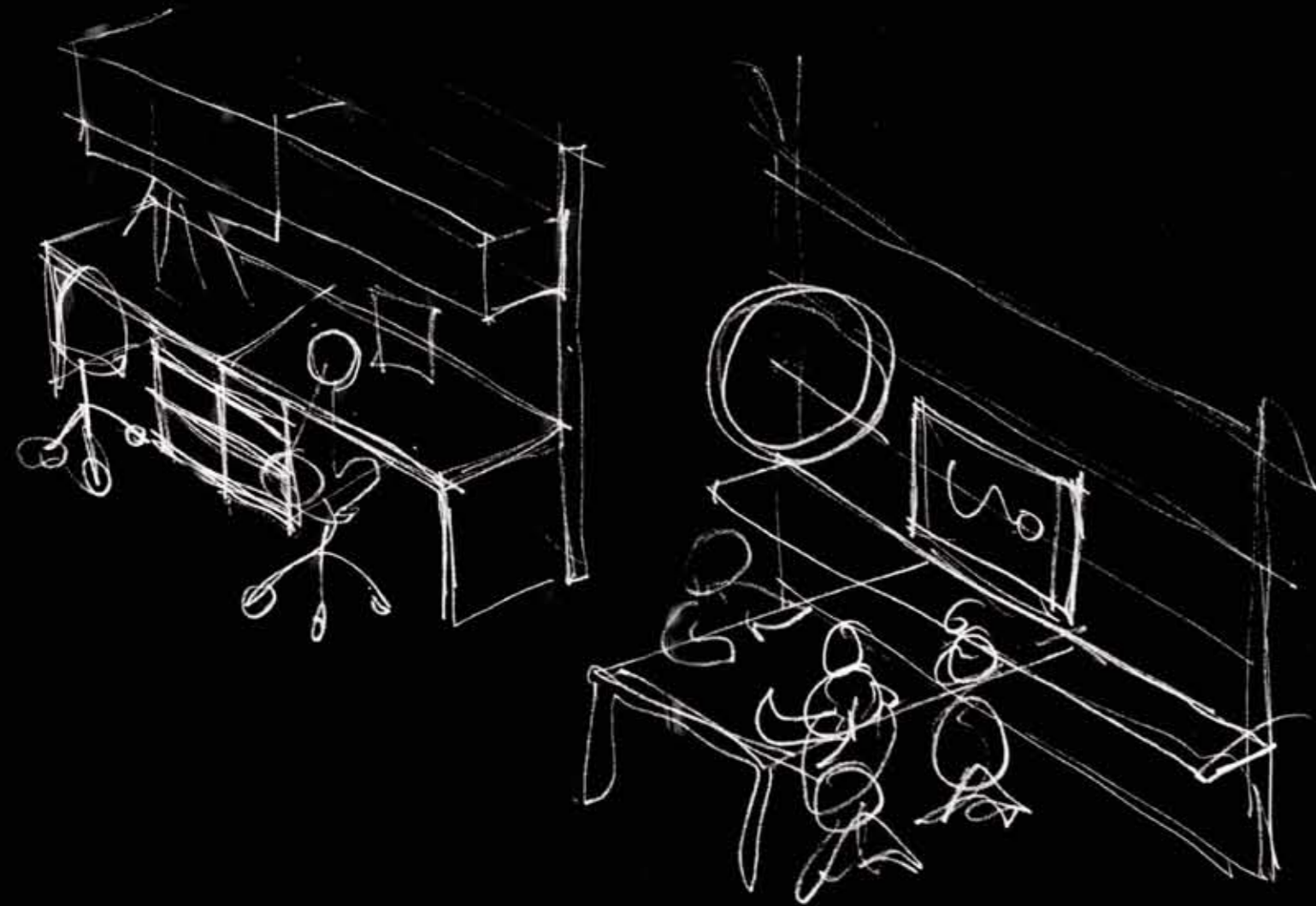

# DEFINIRE LO SPAZIO

**CONTROPARETE:**  
**Accessoriabile**  
**Polivalente**  
**Fonoassorbente**

**DEFINE THE SPACE**

**FALSE WALL:**

Multipurpose

Can be accessorised

Sound damping

**DEFINIR L'ESPACE**

**CONTRE-PARI :**

Polyvalente

équipable

Anti-bruit

**RAUMDEFINITION**

**WANDVERKLEIDUNG:**

Multifunktional

Für Accessoires geeignet

Schalldämpfend

**DEFINIR EL ESPACIO**

**CONTRA-PARED:**

Polivalente

Equipable con accesorios

Fonoabsorbente

h

98

140

170

210



**Postazione singola**  
Single workstation  
Poste individuel  
Einzelner Büroarbeitsplatz  
Puesto de trabajo individual

**Parete attrezzata con piani in vetro.**  
Fitted wall with glass tops  
Paroi équipée de plateaux en verre.  
Wand mit Glasplatten.  
Pared equipada con planos de vidrio.

**Operativo multiplo con pannello frontale**  
Multiple desks with front panel  
Multi-opérationnel avec panneau frontal  
Mehrfach-Büroarbeitsplatz mit Frontblende  
Operativo múltiple con panel frontal

**Parete attrezzata con piani in vetro.**  
Fitted wall with H glass tops  
Paroi équipée de plateaux en verre.  
Wand mit Glasplatten.  
Pared equipada con planos de vidrio.

**Postazione singola con piano laterale**  
Single workstation with side top  
Poste simple avec plateau latéral  
Einzelplatz mit Anbauplatte  
Postación de trabajo individual con sobre de mesa lateral

**Parete attrezzata con contenitori ad ante basculanti serigrafate**  
Fitted wall with storage units with swivelling opal glass screen-printed doors  
Paroi équipée d'armoires avec portes basculantes sérigraphiées.  
Wand mit Hängeschränken mit bedruckten Klappfronten.  
Pared equipada con contenedores con puertas basculantes serigrafadas.

**Postazione singola con elemento di servizio**  
Single workstation with service unit  
Poste individuel avec élément de service  
Beistellmöbel  
Puesto de trabajo individual con elemento de servicio

**Parete attrezzata con pensili con ante basculanti in vetro opalino.**  
Fitted wall with hanging units with swivelling opal glass screen-printed doors  
Paroi équipée d'éléments hauts avec portes basculantes en verre opalin portes sérigraphiées  
Wand mit Hängeschränken mit Opalglassklapptüren, bedruckten Türen  
Pared equipada con muebles coligantes con puertas basculantes en vidrio opalino H. puertas serigrafadas

**Operativi singoli in appoggio su parete con cassettera**  
Single desks resting on the wall with pedestal with screen-printed doors  
Opérationnels individuels en appui sur paroi avec caisson avec portes sérigraphiées  
Einzelne Büroarbeitsplätze aufliegend am Schubadenelement mit bedruckten Fronten  
Operativos individuales apoyados sobre pared con cajonera con puertas serigrafadas

**Parete attrezzata con contenitori con ante serigrafate**  
Fitted wall with screen-printed doors  
Paroi équipée avec portes sérigraphiées  
Wand mit bedruckten Türen  
Pared equipada con puertas serigrafadas

**Parete attrezzata con pannello fonoassorbente e contenitori con ante serigrafate**  
Storage wall with acoustic insulation panel and hanged boxes with serigraphy on the door  
Cloison armoire avec panneau phono-assorbant et rangement avec porte sérigraphée  
Wand mit bedruckten Türen  
Tabique equipado con panel de aislamiento acústico y mueble con puerta serigrafada

**POLIVALENTE:** le possibili aggregazioni tra parete e scrivanie, creano diverse aree di lavoro funzionali all'attività.

**1** Wall with workstations joined in line at the front.  
**Paroi avec postes associables en ligne.**  
 Wand mit gerader, frontal angeordneten Büroplätzen.  
 Pared con puestos de trabajo agregados en línea frontales.



1  
2  
3



**2** Wall with double workstations with shared structures resting on the wall and with screen.  
**Paroi avec postes doubles avec structures partagées en appui sur la paroi et avec écrans.**  
 Wand mit doppelten Büroarbeitsplätzen mit geteilter Struktur, aufliegend an der Wand oder mit Blende.  
 Pared con puestos de trabajo dobles con estructuras compartidas apoyadas a la pared y con pantalla.

**3** Wall with single workstations with side top resting on the wall.  
**Paroi avec postes individuels avec plateau latéral en appui sur la paroi.**  
 Wand mit einzelnen Büroarbeitsplätzen mit seitlicher Platte, aufliegend an der Wand.  
 Pared con puestos de trabajo individuales con plano lateral apoyado en la pared.



2  
4



**4** Wall with hanging units and shelves in varying heights.  
**Paroi avec éléments hauts et étagères de différentes hauteurs.**  
 Wand mit Hängeschrank und Borden in verschiedenen Höhen.  
 Pared con contenedores colgantes y repisas en varias alturas.



**MULTIPURPOSE:** possibilities of matching walls and desks to create different work areas according to their function.  
**POLYVALENT :** les différentes possibilités d'associations entre les parois et les bureaux créent diverses zones de travail fonctionnelles par rapport à l'activité.  
**MULTIFUNKTIONELL:** Durch die diversen Anordnungsmöglichkeiten der Wand und Schreibtische können je nach Aktivität verschiedene, funktionelle Arbeitsbereiche eingerichtet werden.  
**POLIVALENTE:** las posibles combinaciones entre pared y escritorios, crean diversas áreas de trabajo funcionales a la actividad.

# PROGETTARE E ARREDARE

Contenere  
Archiviare  
Ordinare

Store  
File  
Tidy  
Contenir  
Archiver  
Ranger  
Stauraum  
Archiv  
Ordnung  
Contener  
Archivar  
Ordenar



Essenziali ante scorrevoli in vetro, in melaminico o in laccato, racchiudono moduli contenitori, valorizzando lo spazio di lavoro.



Simple sliding glass doors close the storage units for an attractive, organised work area.

Des portes en verre coulissantes essentielles refermant les modules armoires tout en valorisant l'espace de travail.

Essenzielle Glasschiebetüren verkleiden Behältermodule und lassen einen wertvollen Büroraum entstehen.

Esenciales puertas corredizas de vidrio encierran módulos contenedores, valorizando el espacio de trabajo.







FRASSINO  
ASH



ROVERE  
OAK



FAGGIO  
BEECH



NOCE  
WALNUT



NOCE CANALETTO  
CANALETTO WALNUT



WENGÉ  
WENGÉ

FRASSINO



ROVERE



FAGGIO



NOCE



NOCE CANALETTO



WENGÉ



FRASSINO



ROVERE



FAGGIO



NOCE



NOCE CANALETTO



WENGÉ



H 58,5



42



42



H 57

39,8



39,8

H 53,6



79,6



79,6



79,6



69,2

H 82,4



100



100

H 159,2



100



100

H 165,6



198



198

H 197,6



100



100

H 204



198



198



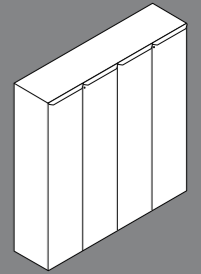
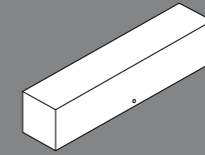
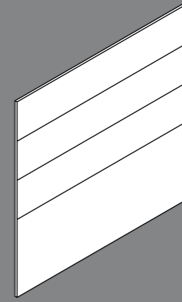
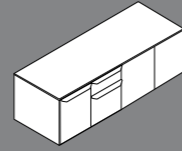
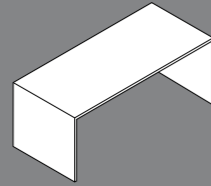
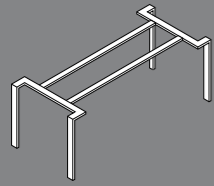

STRUTTURA STRUCTURE

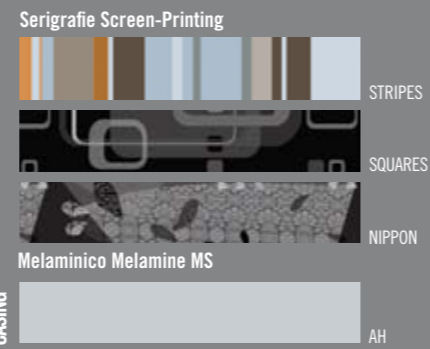
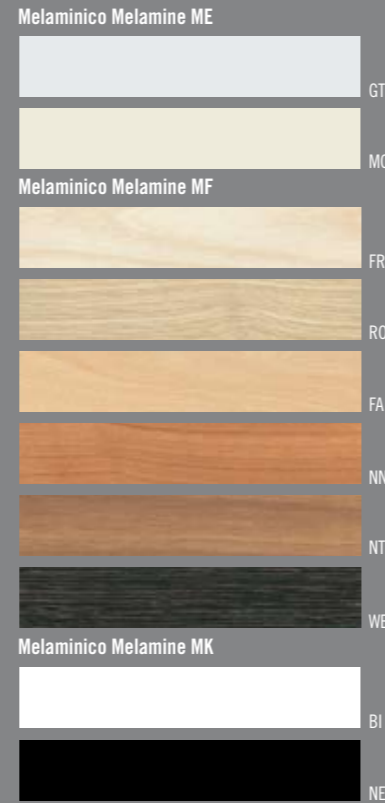

SCOCIA CASING

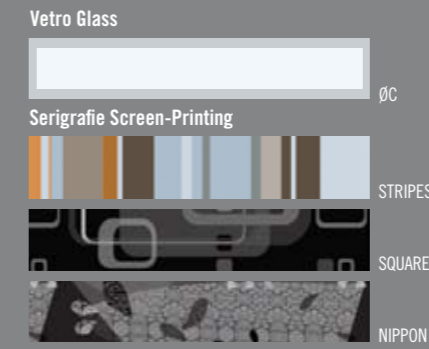
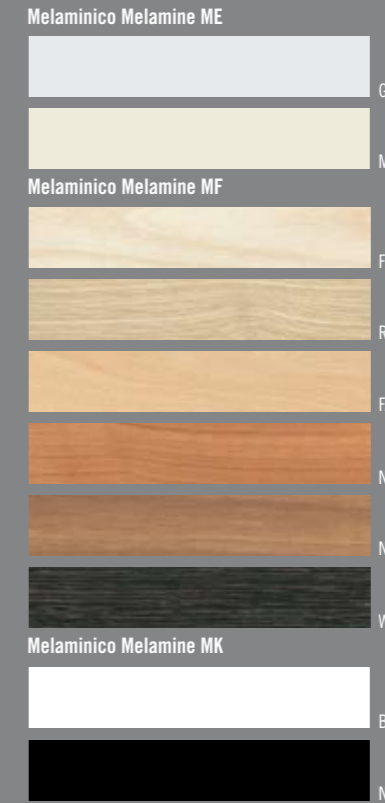
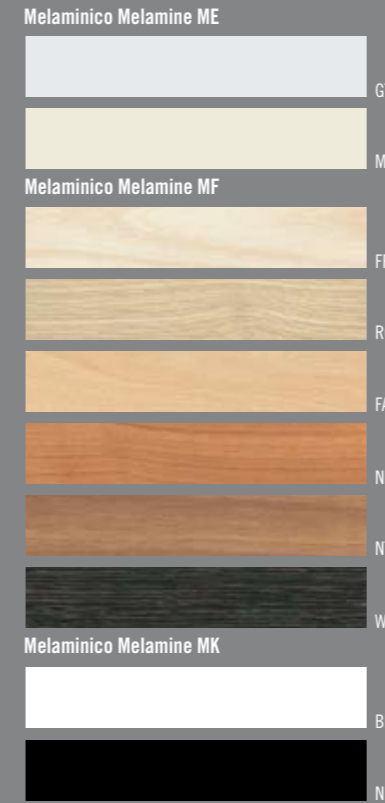

SCOCIA CASING

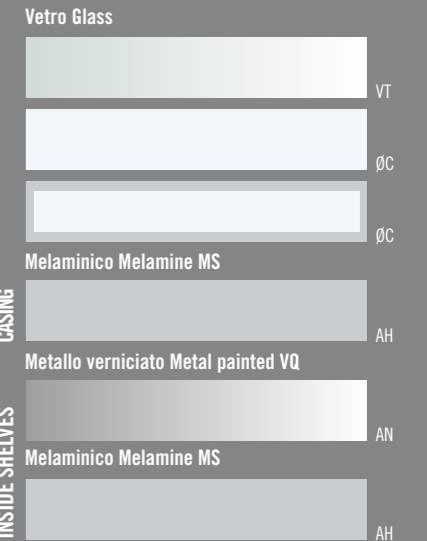
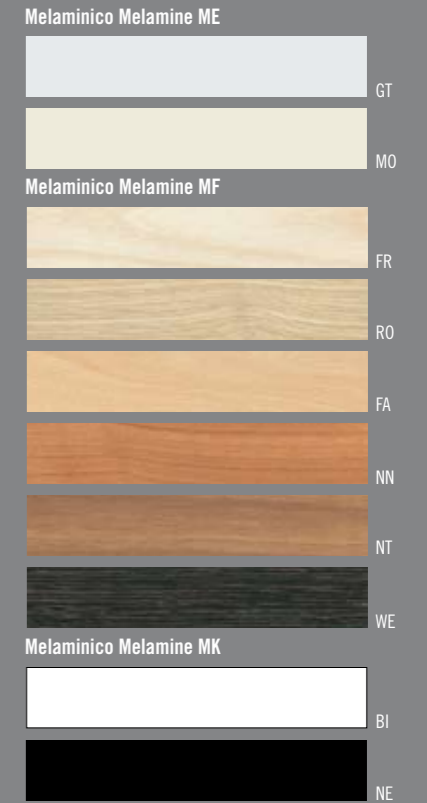

RIPIANI INTERNI INSIDE SHELVES

Following the path that was undertaken a few years ago, grasping the messages given by modern architecture and technological development, carefully analysing the changing world of work and the results that have been reached so far, my desk is our motivation to continue our research into the innovation that has always distinguished frezza creativity in office solutions.

Arch. Sergio Lion

Le parcours accompli ces dernières années, réunissant architecture contemporaine, évolution technologiques et analyse attentive des métamorphoses du monde du travail, a débouché sur la ligne my desk qui représente une stimulation pour poursuivre la recherche et l'innovation qui distingue depuis toujours la créativité de frezza au niveau des solutions pour bureau.

Arch. Sergio lion

Aus der betrachtung des in diesen jahren eingeschlagenen wegs, auf dem die signale der zeitgenössischen architektur, der evolution der technologie erfasst und die mutation der arbeitswelt aufmerksam analysiert wurden, stellt my desk angesichts der errungenen ziele die motivation einer weiteren forschung nach innovation dar, durch die sich die kreativität der firma frezza im bürobereich auszeichnet.

Arch. Sergio lion

De la lectura del camino empezado en estos años, en los que han sido acogidos los mensajes de la arquitectura contemporánea, de la evolución de las tecnologías, en el atento análisis de las mutaciones del mundo del trabajo, verificados los resultados alcanzados hasta el momento, MY DESK representa el estímulo a continuar en la investigación y la innovación que distingue la creatividad de Frezza en la office solution.

Arch. Sergio Lion



**D**alla lettura del percorso intrapreso in questi anni, in cui sono stati recepiti i messaggi dell'architettura contemporanea, dell'evoluzione delle tecnologie, nell'attenta analisi delle mutazioni del mondo del lavoro, verificati i risultati fin qui raggiunti, MY DESK rappresenta lo stimolo a continuare nella ricerca e nell'innovazione che contraddistingue la creatività Frezza nell'office solution.

Arch. Sergio Lion  
designer MY DESK

**Scrivanie con gamba pannellata**  
Desk with panelled leg - Wangenschreibtisch - Bureau avec pied panneau - Mesa con pata panel

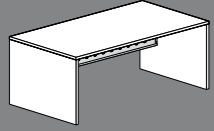

SE0502 L120 P80 H72  
SE0504 L140 P80 H72  
SE0506 L160 P80 H72  
SE0508 L180 P80 H72  
SE0510 L200 P80 H72

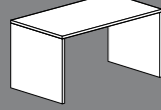

SE0441 L80 P62 H72  
SE0442 L100 P62 H72  
SE0443 L120 P62 H72

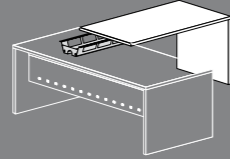

SE0431 L80 P62 H72  
SE0432 L100 P62 H72  
SE0433 L120 P62 H72

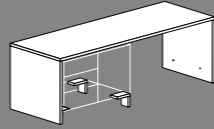

SE0428 L187,5 P62 H72

SE0430 L187,5 P62 H72 (con piedini)

**Scrivanie**  
Desks - Schreibtische - Bureaux - Mesas

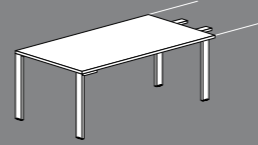

SE1532 L120 P80 H72  
SE1534 L140 P80 H72  
SE1536 L160 P80 H72  
SE1538 L180 P80 H72  
SE1540 L200 P80 H72

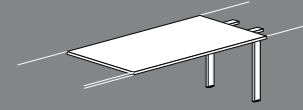

SE2532 L120 P80 H72  
SE2534 L140 P80 H72  
SE2536 L160 P80 H72  
SE2538 L180 P80 H72  
SE2540 L200 P80 H72

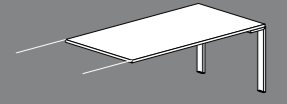

SE3532 L120 P80 H72  
SE3534 L140 P80 H72  
SE3536 L160 P80 H72  
SE3538 L180 P80 H72  
SE3540 L200 P80 H72

**Scrivanie con gamba pannellata e struttura metallica**  
Desk with panelled leg and metal structure - Wangenschreibtisch mit Stahlgestell - Bureau avec pied panneau et structure métallique - Mesa con pata panel y estructura de metal

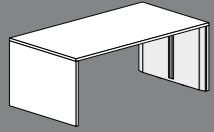

SE5514 L140 P80 H72  
SE5516 L160 P80 H72  
SE5518 L180 P80 H72  
SE5520 L200 P80 H72

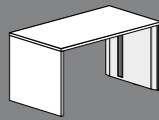

SE0461 L80 P62 H72  
SE0462 L100 P62 H72  
SE0463 L120 P62 H72  
SE0464 L180 P62 H72  
SE0465 L200 P62 H72

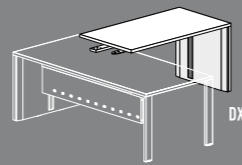

SE0451 L80 P62 H72  
SE0452 L100 P62 H72  
SE0453 L120 P62 H72

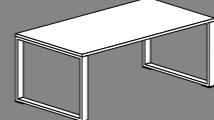

SQ0512 L120 P80 H72  
SQ0514 L140 P80 H72  
SQ0516 L160 P80 H72  
SQ0518 L180 P80 H72  
SQ0520 L200 P80 H72

SQ0528 L180 P90 H72  
SQ0530 L200 P90 H72

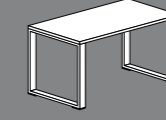

SQ0411 L80 P62 H72  
SQ0412 L100 P62 H72  
SQ0413 L120 P62 H72

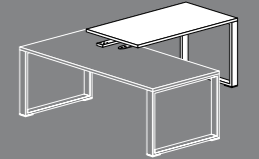

SQ0401 L80 P62 H72  
SQ0402 L100 P62 H72  
SQ0403 L120 P62 H72

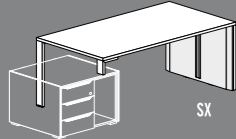

SE7516 (Dx) L160 P80 H72  
SE7515 (Sx) L160 P80 H72  
SE7518 (Dx) L180 P80 H72  
SE7517 (Sx) L180 P80 H72  
SE7520 (Dx) L200 P80 H72  
SE7519 (Sx) L200 P80 H72

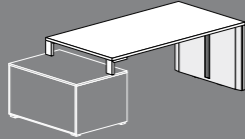

SE6516 L160 P80 H72  
SE6518 L180 P80 H72  
SE6520 L200 P80 H72

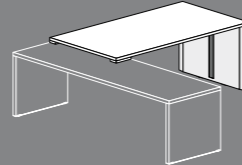

SE8516 L160 P80 H72  
SE8518 L180 P80 H72  
SE8520 L200 P80 H72

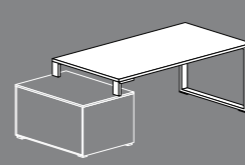

SQ1516 L160 P80 H72  
SQ1518 L180 P80 H72  
SQ1520 L200 P80 H72

SQ1528 L180 P90 H72  
SQ1530 L200 P90 H72

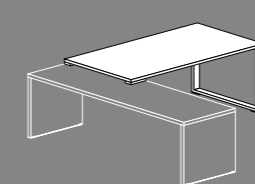

SQ3516 L160 P80 H72  
SQ3518 L180 P80 H72  
SQ3520 L200 P80 H72

SQ3528 L180 P90 H72  
SQ3530 L200 P90 H72

**Scrivanie**  
Desks - Schreibtische - Bureaux - Mesas

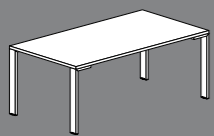

SE0512 L120 P80 H72  
SE0514 L140 P80 H72  
SE0516 L160 P80 H72  
SE0518 L180 P80 H72  
SE0520 L200 P80 H72

SE0528 L180 P90 H72  
SE0530 L200 P90 H72

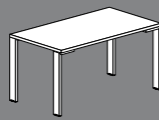

SE0411 L80 P62 H72  
SE0412 L100 P62 H72  
SE0413 L120 P62 H72

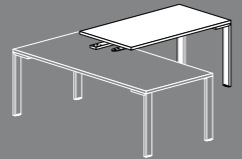

SE0401 L80 P62 H72  
SE0402 L100 P62 H72  
SE0403 L120 P62 H72

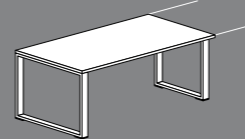

SQ1532 L120 P80 H72  
SQ1534 L140 P80 H72  
SQ1536 L160 P80 H72  
SQ1538 L180 P80 H72  
SQ1540 L200 P80 H72

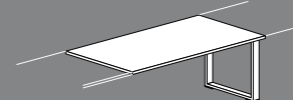

SQ2532 L120 P80 H72  
SQ2534 L140 P80 H72  
SQ2536 L160 P80 H72  
SQ2538 L180 P80 H72  
SQ2540 L200 P80 H72

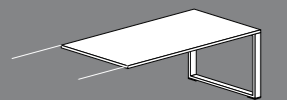

SQ3532 L120 P80 H72  
SQ3534 L140 P80 H72  
SQ3536 L160 P80 H72  
SQ3538 L180 P80 H72  
SQ3540 L200 P80 H72

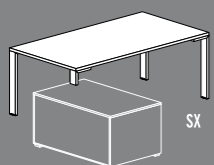

SE2516 (Dx) L160 P80 H72  
SE2515 (Sx) L160 P80 H72  
SE2518 (Dx) L180 P80 H72  
SE2517 (Sx) L180 P80 H72  
SE2520 (Dx) L200 P80 H72  
SE2519 (Sx) L200 P80 H72

SE2528 (Dx) L180 P90 H72  
SE2527 (Sx) L200 P90 H72  
SE2530 (Dx) L180 P90 H72  
SE2529 (Sx) L200 P90 H72

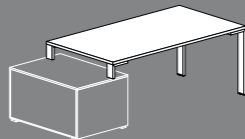

SE1516 L160 P80 H72  
SE1518 L180 P80 H72  
SE1520 L200 P80 H72

SE1528 L180 P90 H72  
SE1530 L200 P90 H72

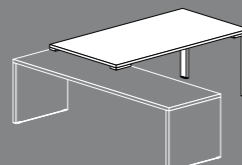

SE3516 L160 P80 H72  
SE3518 L180 P80 H72  
SE3520 L200 P80 H72

SE3528 L180 P90 H72  
SE3530 L200 P90 H72

**Specials**

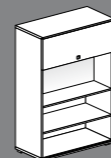

SE0920 L100 P46 H159,2

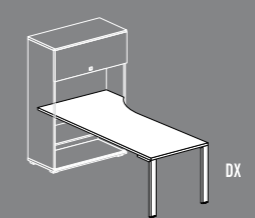

SE6528 (Dx) L180 P80/95,9 H72  
SE6527 (Sx) L180 P80/95,9 H72

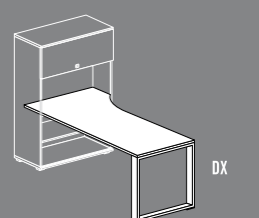

SQ6528 (Dx) L180 P80/95,9 H72  
SQ6527 (Sx) L180 P80/95,9 H72



**Scrivanie doppie**  
Double desks - Doppeltische - Bureaux doubles - Mesas dobles

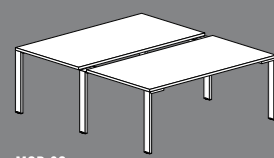

**MOD 80**  
SE0552 L120 P170 H72  
SE0554 L140 P170 H72  
SE0556 L160 P170 H72  
SE0558 L180 P170 H72  
SE0560 L200 P170 H72

**MOD 90**  
SE0568 L180 P190 H72  
SE0570 L200 P190 H72

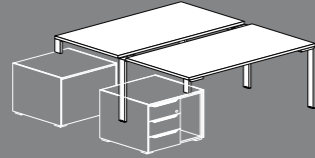

**MOD 80**  
SE2556 L160 P170 H72  
SE2558 L180 P170 H72  
SE2560 L200 P170 H72

**MOD 90**  
SE2568 L180 P190 H72  
SE2570 L200 P190 H72

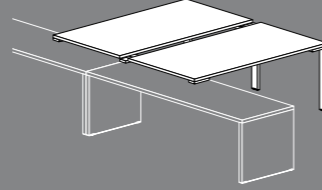

**MOD 80**  
SE3556 L160 P170 H72  
SE3558 L180 P170 H72  
SE3560 L200 P170 H72

**MOD 90**  
SE3568 L180 P190 H72  
SE3570 L200 P190 H72

**Scrivanie doppie SQUARE**  
Double desks - Doppeltische - Bureaux doubles - Mesas dobles

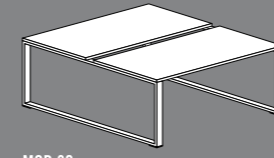

**MOD 80**  
SQ0552 L120 P170 H72  
SQ0554 L140 P170 H72  
SQ0556 L160 P170 H72  
SQ0558 L180 P170 H72  
SQ0560 L200 P170 H72

**MOD 90**  
SQ0568 L180 P190 H72  
SQ0570 L200 P190 H72

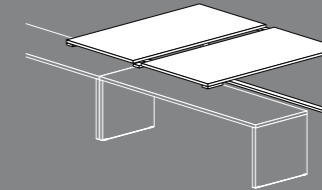

**MOD 80**  
SQ3556 L160 P170 H72  
SQ3558 L180 P170 H72  
SQ3560 L200 P170 H72

**MOD 90**  
SQ3568 L180 P190 H72  
SQ3570 L200 P190 H72

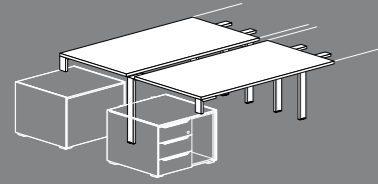

SE6564 L140 P170 H72  
SE6566 L160 P170 H72  
SE6568 L180 P170 H72  
SE6570 L200 P170 H72

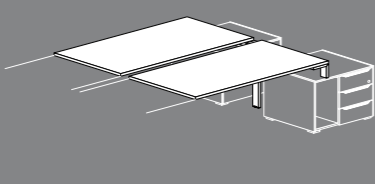

SE8564 L140 P170 H72  
SE8566 L160 P170 H72  
SE8568 L180 P170 H72  
SE8570 L200 P170 H72

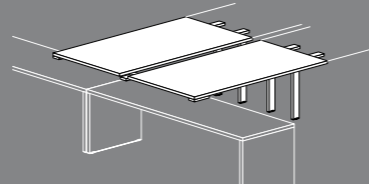

SE4552 L120 P170 H72  
SE4554 L140 P170 H72  
SE4556 L160 P170 H72  
SE4558 L180 P170 H72  
SE4560 L200 P170 H72

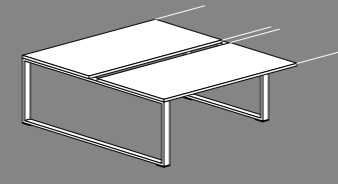

SQ6552 L120 P170 H72  
SQ6554 L140 P170 H72  
SQ6556 L160 P170 H72  
SQ6558 L180 P170 H72  
SQ6560 L200 P170 H72

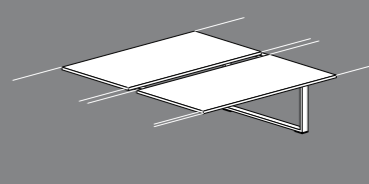

SQ7552 L120 P170 H72  
SQ7554 L140 P170 H72  
SQ7556 L160 P170 H72  
SQ7558 L180 P170 H72  
SQ7560 L200 P170 H72

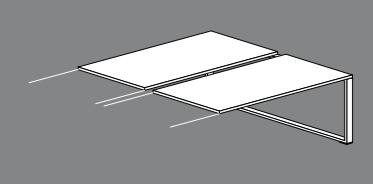

SQ8552 L120 P170 H72  
SQ8554 L140 P170 H72  
SQ8556 L160 P170 H72  
SQ8558 L180 P170 H72  
SQ8560 L200 P170 H72

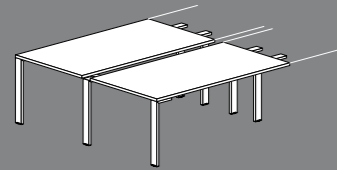

SE6552 L120 P170 H72  
SE6554 L140 P170 H72  
SE6556 L160 P170 H72  
SE6558 L180 P170 H72  
SE6560 L200 P170 H72

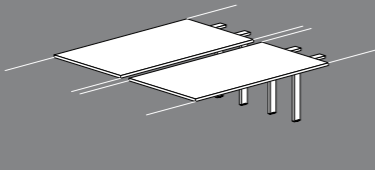

SE7552 L120 P170 H72  
SE7554 L140 P170 H72  
SE7556 L160 P170 H72  
SE7558 L180 P170 H72  
SE7560 L200 P170 H72

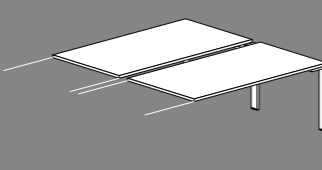

SE8552 L120 P170 H72  
SE8554 L140 P170 H72  
SE8556 L160 P170 H72  
SE8558 L180 P170 H72  
SE8560 L200 P170 H72

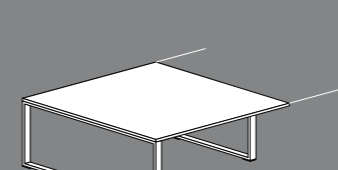

SQ1626 L160 P160 H72  
SQ1628 L180 P160 H72

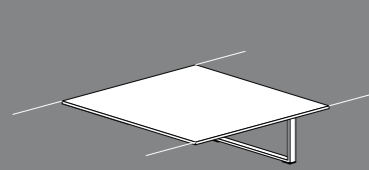

SQ1636 L160 P160 H72  
SQ1638 L180 P160 H72

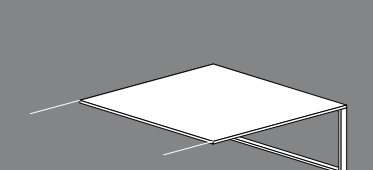

SQ1646 L160 P160 H72  
SQ1648 L180 P160 H72

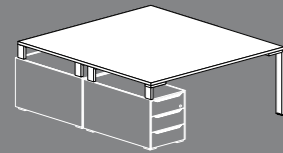

SE1552 L120 P160 H72  
SE1554 L140 P160 H72  
SE1556 L160 P160 H72  
SE1558 L180 P160 H72  
SE1560 L200 P160 H72

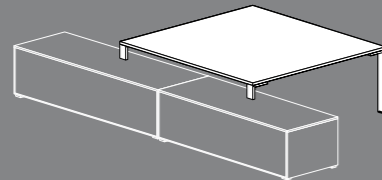

SE1537 L160 P160 H72  
SE1539 L180 P160 H72

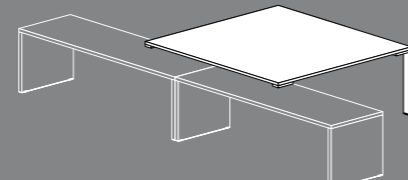

SE2537 L160 P160 H72  
SE2539 L180 P160 H72

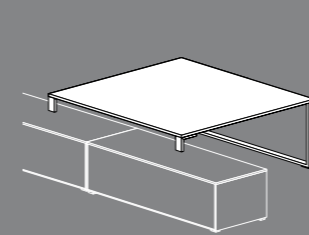

SQ1537 L160 P160 H72  
SQ1539 L180 P160 H72

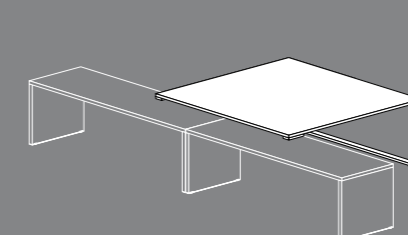

SQ2537 L160 P160 H72  
SQ2539 L180 P160 H72

**Tavoli riunione**  
Meeting tables - Besprechungstische - Tables réunion - Mesa de reuniones

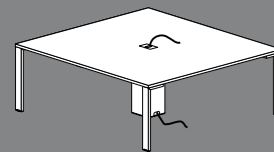

SE1616 L160 P160 H72

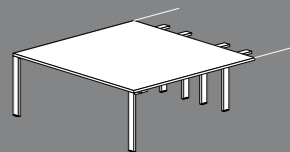

SE1626 L160 P160 H72  
SE1628 L180 P160 H72

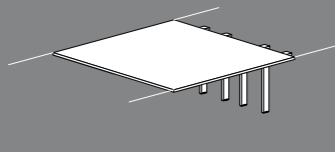

SE1636 L160 P160 H72  
SE1638 L180 P160 H72

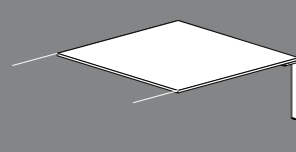

SE1646 L160 P160 H72  
SE1648 L180 P160 H72

**Tavoli**  
Tables - Tische - Tables - Mesas

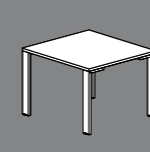

SE1608 L80 P80 H72

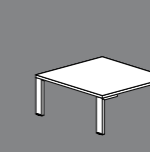

SE1606 L62 P62 H40  
SE1608 L80 P80 H40

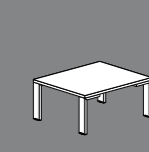

SE1609 L80 P62 H40

**Complementi per scrivanie**  
Desks extension - Schreibtischbauelemente - Complements pour bureaux - Complementos para mesas

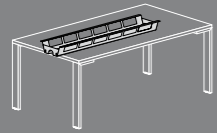

**SE9212** mod.120 L74 P25,5 H11  
**SE9214** mod.140 L94 P25,5 H11  
**SE9216** mod.160 L114 P25,5 H11  
**SE9218** mod.180 L134 P25,5 H11  
**SE9220** mod.200 L154 P25,5 H11



**SE0312** mod.120 L74,2 P2 H28,6  
**SE0314** mod.140 L94,2 P2 H28,6  
**SE0316** mod.160 L114,2 P2 H28,6  
**SE0318** mod.180 L134,2 P2 H28,6  
**SE0320** mod.200 L154,2 P2 H28,6

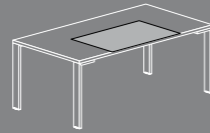

**TG9508** L80 P50

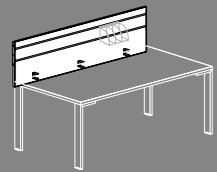

**SE0702** L120 P1,8 H48  
**SE0704** L140 P1,8 H48  
**SE0706** L160 P1,8 H48  
**SE0708** L180 P1,8 H48  
**SE0710** L200 P1,8 H48

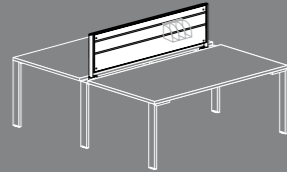

**SE0712** L119 P4 H40  
**SE0714** L139 P4 H40  
**SE0716** L159 P4 H40  
**SE0718** L179 P4 H40  
**SE0720** L199 P4 H40

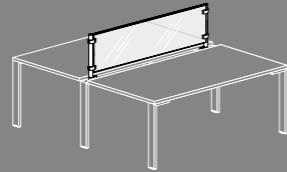

**SE0722** L119 P0,8 H40  
**SE0724** L139 P0,8 H40  
**SE0726** L159 P0,8 H40  
**SE0728** L179 P0,8 H40  
**SE0729** L179 P0,8 H40

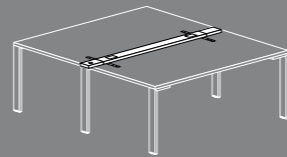

**SE9612** L120 P10 H2,8  
**SE9614** L140 P10 H2,8  
**SE9616** L160 P10 H2,8  
**SE9618** L180 P10 H2,8  
**SE9620** L200 P10 H2,8

**Cassettiere**  
Pedestals - Rollcontainer - Caissons - Cajoneras



**CS0801**  
L42 P57,5 H55,5



**CS0802**  
L42 P57,5 H55,5



**SE0803**  
L42 P55,5 H58,5



**SE0804**  
L42 P55,5 H58,5



**SE0801**  
L42,2 P61 H53,6



**SE0802**  
L42,2 P61 H53,6

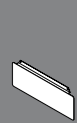

**TV9501**  
L40 H10



**TV9502**  
L30 P2,2 H26,8

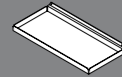

**TV9503**  
L35,3 P16 H2,1

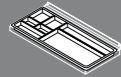

**TGVA**  
L34,7 P15,7 H1,8

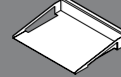

**TV9504**  
L30,7 P23,5 H4,5



**TV9505**  
L21,7 P16 H4,5



**TV9506**  
L11,2 P16 H4,5



**TV9507**  
L7,5 P3 H10

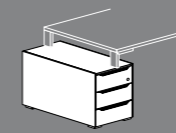

**SE0813**  
L42,2 P79,6 H53,6

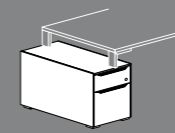

**SE0814**  
L42,2 P79,6 H53,6

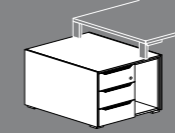

**SE0916 (Dx)**  
**SE0917 (Sx)**  
L69,2 P79,6 H53,6

**Elementi di servizio**  
Service units - Beistellmöbel - Meubles de service - Muebles auxiliares

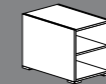

**SE0901**  
L39,8 P59 H52,4  
**SE0911**  
L50 P59 H52,4



**SE0902 (Dx) - SE0903 (Sx)**  
L39,8 P59 H52,4  
**SE0912 (Dx) - SE0913 (Sx)**  
L50 P59 H52,4



**SE0811**  
L39,8 P59 H52,4



**SE0812**  
L39,8 P59 H52,4

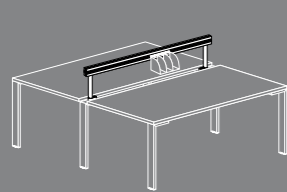

**SE072** L116,6 P5,7  
**SE074** L136,6 P5,7  
**SE076** L156,6 P5,7  
**SE078** L176,6 P5,7  
**SE079** L196,6 P5,7

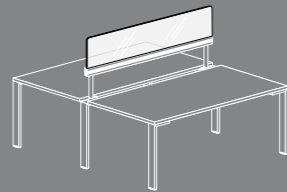

L115,8 P0,5 H35,5  
L135,8 P0,5 H35,5  
L155,8 P0,5 H35,5  
L175,8 P0,5 H35,5

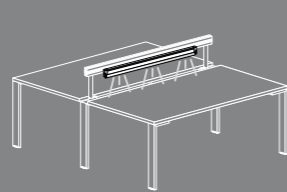

**BSLA07** L93 P1,8 H4,5

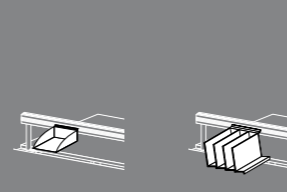

**WRA5** L16,6 P24 H7

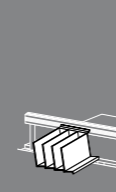

**WRSF** L25 P20 H16

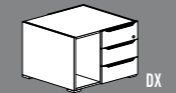

**SE0908 (Dx) - SE0909 (Sx)**  
L66,8 P61 H52,4

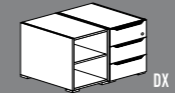

**SE0930 (Dx) - SE0931 (Sx)**  
L79,6 P59 H52,4  
**SE0940 (Dx) - SE0941 (Sx)**  
L89,8 P59 H52,4

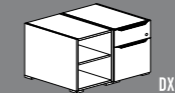

**SE0932 (Dx) - SE0933 (Sx)**  
L79,6 P59 H52,4  
**SE0942 (Dx) - SE0943 (Sx)**  
L89,8 P59 H52,4



**SE0934 (Dx) - SE0935 (Sx)**  
L79,6 P59 H52,4  
**SE0944 (Dx) - SE0945 (Sx)**  
L89,8 P59 H52,4



**SE0936 (Dx) - SE0937 (Sx)**  
L79,6 P59 H52,4  
**SE0946 (Dx) - SE0947 (Sx)**  
L89,8 P59 H52,4

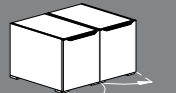

**SE0904**  
L79,6 P59 H52,4  
**SE0914 (Dx) - SE0915 (Sx)**  
L89,8 P59 H52,4

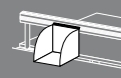

**WRSR** L20 P20 H21,8

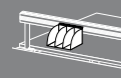

**WRSD** L20 P12 H10

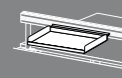

**WRSC** L56 P11 H2,4

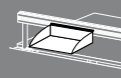

**WRA4** L33 P24 H7

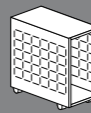

**TK0914**  
L26 P55 H63,5

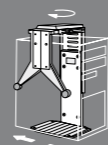

**EEPKA**  
L10÷25 P30 H36÷56

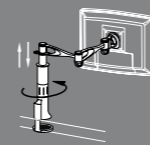

**BS9510**

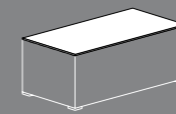

**SETP06** L66,8 P61 Sp1,2  
**SETP08** L79,6 P61 Sp1,2  
**SETP09** L89,8 P61 Sp1,2  
**SETP12** L119,4 P61 Sp1,2  
**SETP14** L139,8 P61 Sp1,2  
**SETP15** L150 P61 Sp1,2  
**SETP16** L159,3 P61 Sp1,2  
**SETP18** L179,7 P61 Sp1,2

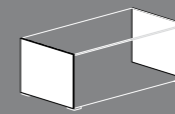

**SEF01** (1 fianco)  
**SEF02** (2 fianchi)  
Sp1,2 P61 H53,6

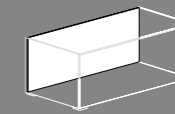

**SESF08** L79,6 Sp1,8 H52,4  
**SESF09** L89,8 Sp1,8 H52,4  
**SESF12** L119,4 Sp1,8 H52,4  
**SESF14** L139,8 Sp1,8 H52,4  
**SESF15** L150 Sp1,8 H52,4  
**SESF16** L159,3 Sp1,8 H52,4  
**SESF18** L179,7 Sp1,8 H52,4

Boiserie

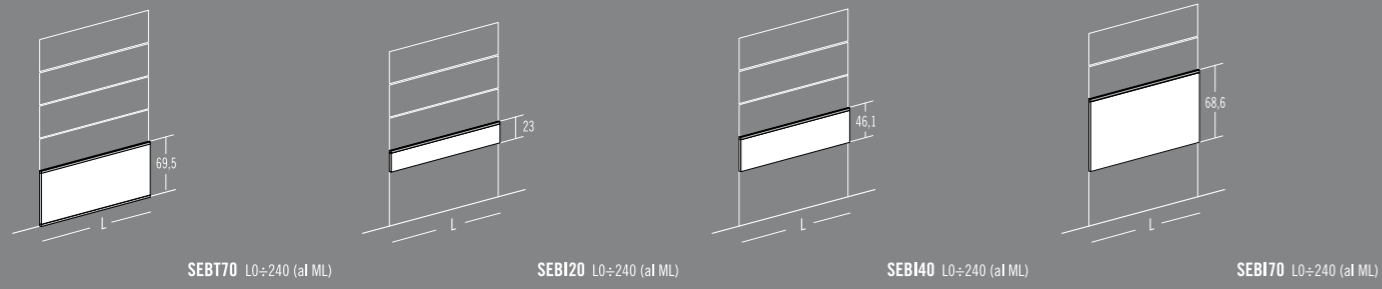

L100 P45,8 H159,6

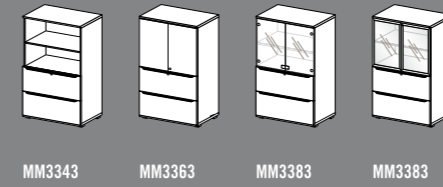

L50 P45,8 H198

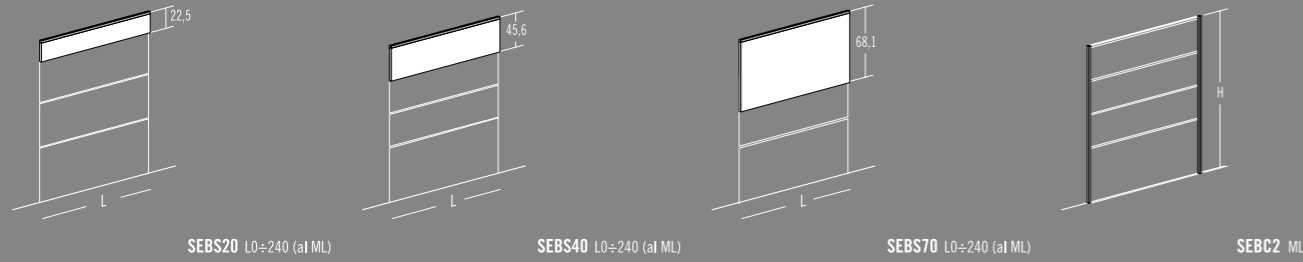
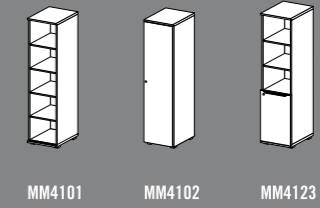

L100 P45,8 H198

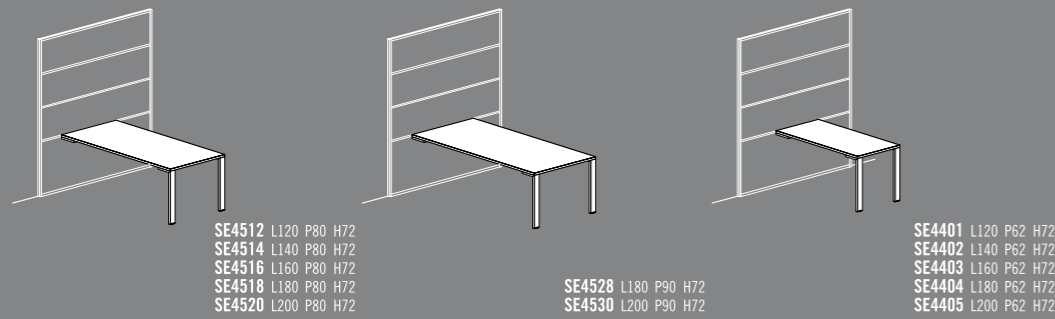
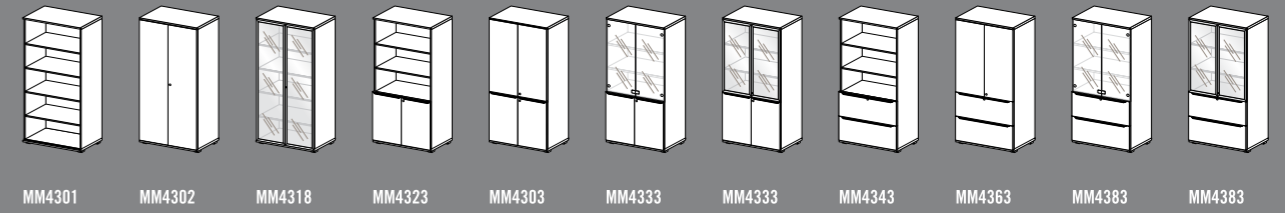

L50 P45,8 H236,4

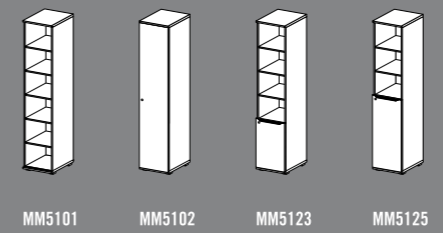

L100 P45,8 H236,4

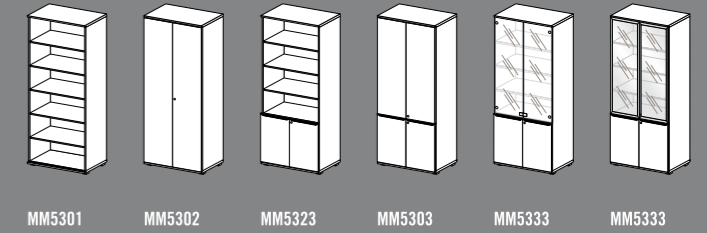

Mobili

Cupboards - Schränke - Meubles - Muebles

L50 P45,8 H82,8

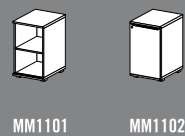

L100 P45,8 H82,8

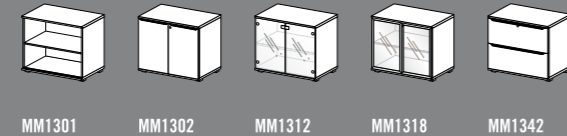

L100 P45,8 H236,4

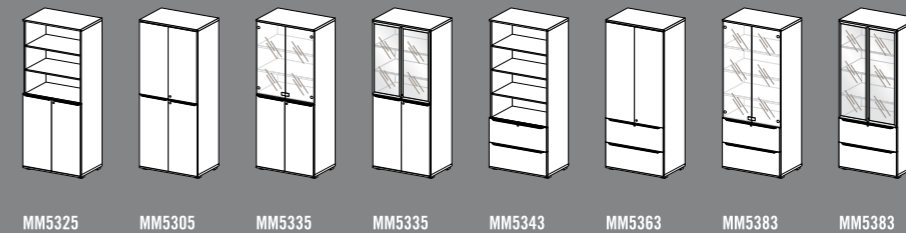

L50 P45,8 H159,6

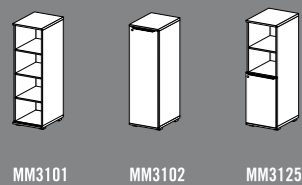

L100 P45,8 H159,6

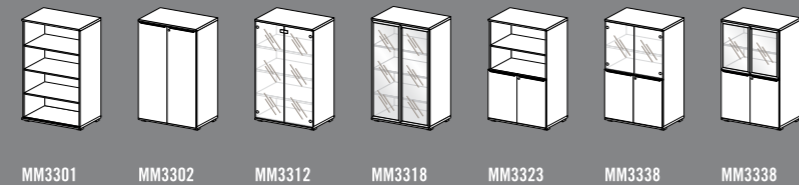

L198 P49,2 H165,6

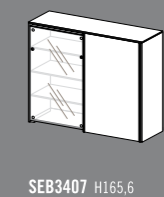

L198 P49,2 H204

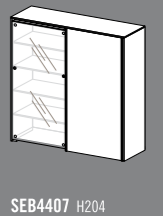



Le immagini e i disegni contenuti nel presente catalogo sono puramente rappresentativi di questo prodotto e possono subire variazioni e modifiche anche senza preavviso. Pertanto nella scelta degli articoli per la compilazione dell'ordine, fa fede solamente quanto contenuto nel listino in vigore.

The photographs and drawings in this catalogue are only a representation of products and may be varied and changed without notice. When choosing articles for your orders, only the details contained in the price-list in force should be considered.

Les images et les dessins présents dans ce catalogue sont uniquement des représentations de ce produit et peuvent subir des variations et des modifications même sans préavis. Par conséquent, une fois les articles choisis, lorsque vous remplirez le bon de commande, référez-vous au tarif en vigueur car il est le seul à faire foi.

Hinweis: Alle in diesem Katalog enthaltenen Abbildungen sind unverbindlich; wir behalten uns das Recht vor, Änderungen oder Verbesserungen ohne Ankündigung durchzuführen. Maßgeblich für die Auswahl der einzelnen zu bastellenden Produkte ist ausschließlich die jeweils gültige Verkaufspreisliste.

Las imágenes y dibujos contenidos en el presente catálogo son puramente representativos de dicho producto y pueden sufrir modificaciones y variaciones incluso sin pre aviso. Por ello les rogamos se guien por la tarifa en vigor a la hora de cumplimentar los pedidos.



**La Frezza SPA è certificata UNI EN ISO 9001:2000 - UNI EN ISO 14001 - attività EA: 23e; 28a.**

Progettazione, produzione e installazione di arredi per l'ufficio, pareti divisorie ed attrezzature e complementi di arredo. Progettazione, produzione e installazione di arredi per il contract. Progettazione e produzione di arredi e complementi per la casa.

**Frezza SPA is UNI EN ISO 9001:2000 - UNI EN ISO 14001 - Activity EA: 23e; 28a certified.**

Development, production and assembling of office furniture, partition and storage walls and furnishing complements. Development, production and assembling of contract furniture. Development and production of home furniture and home complements.

**La Société Frezza SPA est certifiée UNI EN ISO 9001:2000 - UNI EN ISO 14001 - activité EA: 23e; 28a.**

Projet, production et installation d'aménagement pour bureau, cloisons de division et cloisons toutes hauteurs ainsi que compléments d'aménagement. Projet, production et installation d'aménagement pour projet clef en main. Projet et production d'aménagement et compléments pour l'habitat.

**Frezza SPA ist UNI EN ISO 9001:2000 - UNI EN ISO 14001 - Tätigkeit EA: 23e; 28a zertifiziert.**

Entwicklung, Herstellung und Aufbau von Büromöbeln, Trenn- und Schrankwänden und Einrichtungsselementen. Entwicklung, Herstellung und Aufbau von Objekteinrichtungsmöbeln. Entwicklung und Herstellung von Wohnmöbeln- und einrichtungsselementen.

**Frezza SPA ha sido certificada UNI EN ISO 9001:2000 - UNI EN ISO 14001 - actividad EA: 23e; 28a.**

Proyección, producción e instalaciones de mobiliario para la oficina, paredes divisorias y equipadas y complementos de decoración.

Proyección, producción e instalaciones de mobiliario para el contract. Proyección y producción de mobiliario y complementos para la casa.



Bassa emissione di formaldeide  
Low emission of formaldehyde  
Geringfügige Formaldehydstrahlung  
Basse émission de formaldeide  
Baja emisión de formaleidos



Il marchio FSC identifica prodotti contenente legno proveniente da foreste gestite in maniera corretta e responsabile, secondo rigorosi standards ambientali, sociali ed economici. La foresta di origine è stata controllata e valutata in maniera autonoma in conformità a principi stabiliti ed approvati dal "Forest Stewardship Council S.A.". FREZZA SPA ha scelto per questo catalogo carta certificata FSC.

The FSC brand identifies products coming from responsible tree farming, according to very strict environmental, social and economic standards. The forests the wood comes from have been independently controlled and assessed in conformity with the principles established and approved by the "Forest Stewardship Council S.A.". FREZZA SPA has used FSC certified recycled paper for this catalogue.

La marque FSC identifie les produits contenant du bois provenant de forêts gérées de manière correcte et responsable, conformément aux rigoureux standards environnementaux, sociaux et économiques. La forêt d'origine a été contrôlée et évaluée de manière autonome conformément aux principes établis et approuvés par le "Forest Stewardship Council S.A.". Pour ce catalogue de prix, FREZZA SPA a choisi du papier certifié FSC de la papeterie Schneider Papier Italia.

Der FSC-Siegel kennzeichnet Holzprodukte aus korrekter, verantwortungsvoller Waldwirtschaft, nach strengen ökologischen, sozialen und wirtschaftlichen Maßstäben. Der Ursprungswald wurde durch unabhängige Zertifizierungsorganisationen nach verbindlichen Prinzipien der „Forest Stewardship Council S.A.“ getestet und bewertet. Die FREZZA SPA hat sich deswegen beim Druck dieses Katalogs für FSC-zertifiziertes Papier entschieden.

La marca FSC identifica productos que contienen madera procedente de bosques gestionados de manera correcta y responsable, según rigurosos estándares medioambientales, sociales y económicos. El bosque de origen ha sido controlado y evaluado autónomamente de conformidad a principios establecidos y aprobados por el "Forest Stewardship Council S.A.". FREZZA SPA ha elegido para este catálogo papel certificado FSC.

Carta: Algro Design (Sappi) e Phoenixmotion Xenon (Scheufelen)

**art director**  
Genny Canton  
**photo**  
Fausto Trevisan  
**digital images**  
Stefano Adriani  
**layout**  
Francesca Roman  
**copy**  
Federico Bernardi  
**lithography**  
Fotolito Maistri  
**printing**  
Grafiche Antiga  
February 2009

**design management**  
Sergio Lion  
**general coordination**  
Claudio Signori

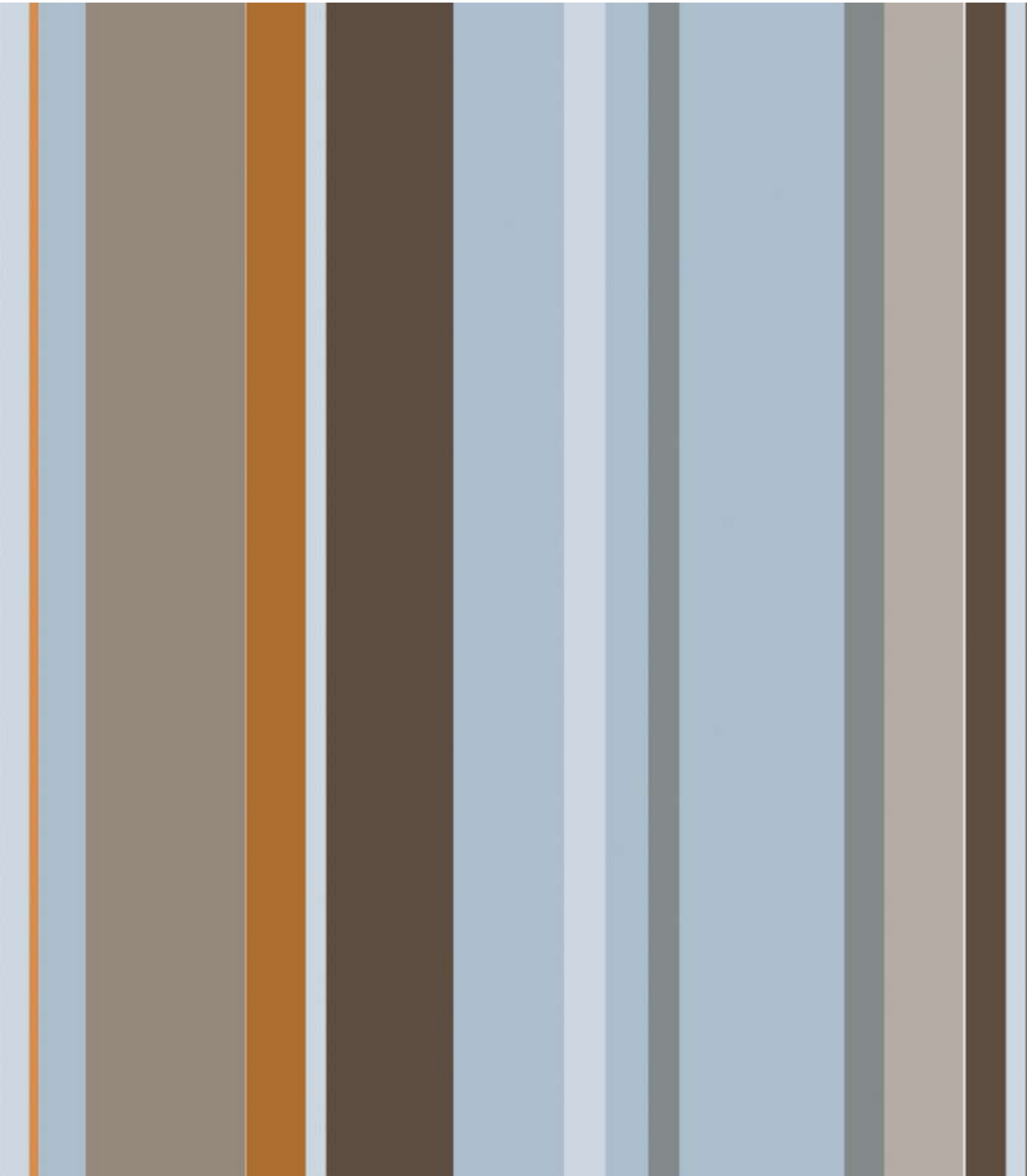

**Frezza Spa** Via Ferret, 11/9  
31020 Vidor (Treviso) Italy  
Phone +39 0423 987601  
Fax +39 0423 987800  
[www.frezza.com](http://www.frezza.com)  
e-mail [info@frezza.com](mailto:info@frezza.com)