

m o o o i[®]



Container Table Top 70x70 | 70Ø

The container table concept is a fully versatile system that has endless composition possibilities to suit your space. With combinations to suit your home, office or public space the container table can far exceed your requirements.

Designer
Year of design
Material
Additional

Marcel Wanders
2002
HPL, LPL, Laquered wood, Stained Wood
These table top sizes will fit on the 10030, 7030 and 4530 container foot.

HPL top - colour

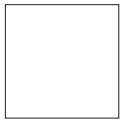

White



Black



Light grey

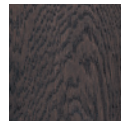

Wenge

LPL top - colour

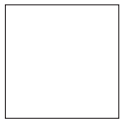

White



Black



Light grey

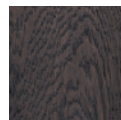

Wenge

MDF with oak veneer - colour

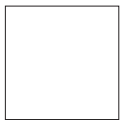

White
RAL 9016



Red
RAL 3020



Orange
RAL 2004



Black
RAL 9005

MDF with oak veneer - colour

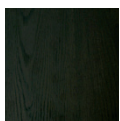

Black

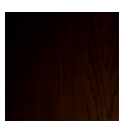

Bloody
brown

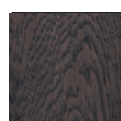

Wenge



Grey
brown



Natural
lacquer



White
wash



Detailing

The edges of the HPL and LPL tops are always black.
HPL tops are also for outdoor use.

Technical

All Container table tops all attach to the container foot in the same way. The Container concept is that sand or treated water can be added to the foot to give it strength and stability. Water must always be treated with an anti-algae additive to prevent the water from becoming stale. There are Hex-bolts on the underside of each table which align with equally spaced holes in the mounting disk.

Maximum divided load per m² = 100kg

Cleaning Instructions

Moooli recommends using a trusted household furniture polish or a regular household spray cleaner and a soft, non-abrasive cloth to create an even sheen. Always read the label of any cleaning products you wish to use on Moooli furniture.

Packaging 70x 70 | 70Ø

HPL

H 3 cm | 1.2"
W 71 cm | 27.9"
D 71 cm | 27.9"

70 x 70

Colli I
Product weight:
8,2 KG | 17,6 lb
With packaging:
10 KG | 22 lb

70Ø

Colli I
Product weight:
6,4 KG | 14,1 lb
With packaging:
8,4 KG | 18,5 lb

LPL

H 4 cm | 1.6"
W 71 cm | 27.9"
D 71 cm | 27.9"

70 x 70

Colli I
Product weight:
9,3 KG | 20,5 lb
With packaging:
11,3 KG | 25 lb

70Ø

Colli I
Product weight:
7,3 KG | 16 lb
With packaging:
9,3 KG | 20,5 lb

Wood

H 8 cm | 3.1"
W 76 cm | 29.9"
D 76 cm | 29.9"

70 x 70

Colli I
Product weight:
15,6 KG | 34,4 lb
With packaging:
17,6 KG | 38,8 lb

70Ø

Colli I
Product weight:
12,3 KG | 27,1 lb
With packaging:
14,3 KG | 31,5 lb

m o o o i[®]

Main dimensions

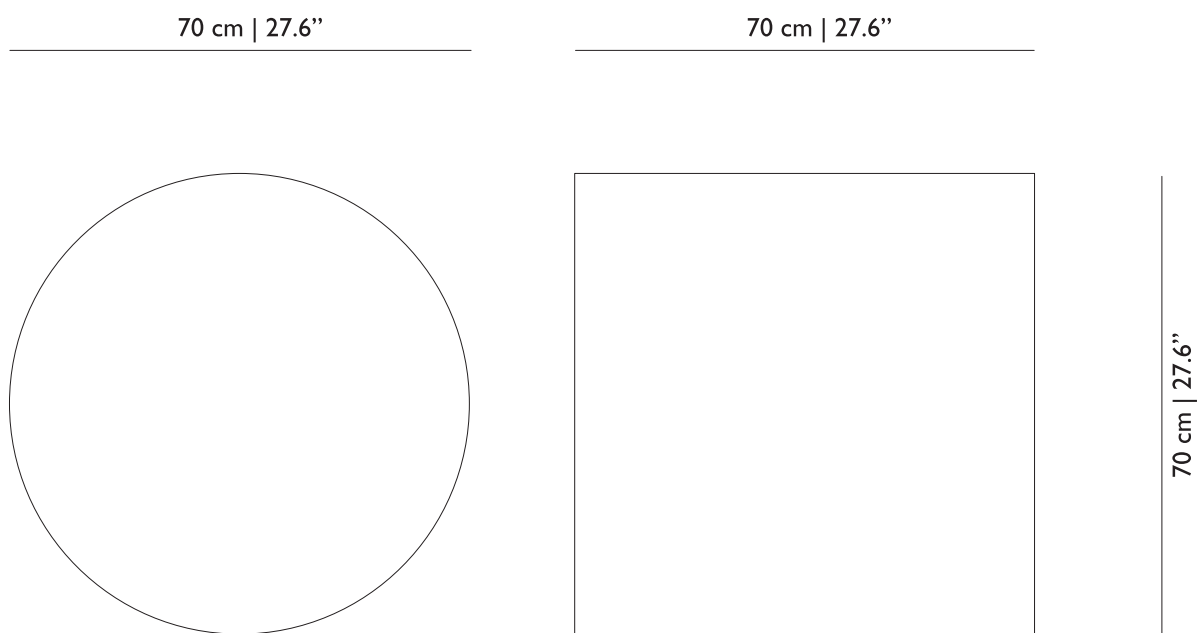

Thickness

HPL: 1,2 cm | 0.5"

LPL: 2,5 cm | 1"

Wood: 4 cm | 1.6"

Fits on:

