

2011

pdf



 **Hola Book**



REV-08-2011

lzf
HANDMADE



HOLA/HOLA MASTIL

Miguel Herranz

Hola, expansive waves

Hola, a creation by Spanish designer Miguel Herranz, is a hanging lamp made up of two sheets of wood veneer. These are structured in a way that convertes them into a shade made up of three waves for three aligned light points. The result is an elegant and genuine object that can grow in different directions (see the Hola Mástil).

It's design is easily adapted to private homes or commercial areas. The hola can be assembled in structures built around a central mast to create a set of lamps with a strong character, perfect for public areas, receptions areas, bars, restaurants, corridors, and so on.

Hola, ondas expansivas

Hola, diseñada por el español Miguel Herranz, es una lámpara de suspensión compuesta por dos chapas de madera que gracias a sus flexiones "apantallan" tres puntos de luz en línea. De este modo se obtiene un elemento elegante y genuino que, además, puede crecer longitudinalmente o en otras direcciones (ver Hola Mástil).

De diseño adaptable al hogar y de enormes posibilidades para espacios comerciales, Hola permite configurar grandes grupos de lámparas anclando pantallas horizontalmente (en el tubo superior) y obtener un efecto de continuidad total de ondas y de iluminación. De este modo se obtienen grupos de lámparas con fuerte y contundente presencia para espacios públicos, como por ejemplo recepciones, barras de bares-restaurantes, pasillos, etc.

HOLA/HOLA MASTIL Miguel Herranz

SUSPENSION
SUSPENSIÓN

INFO

Electrical

Packaging

Dimension

OLA S CHW



Shade / Pantalla

Natural wood /
Madera natural
CHW colors:



20 21 22 24

25 26 27 29

see chart /

ver gráfico

Required /
Requiere
shade mounting /
montaje de
pantalla

WORLD



3 x 11 w
E-27
CFL short
Double tube /
Bajo consumo

Box / **Caja:**
4,3 Kg
0,115 m³
120x30x32 cm

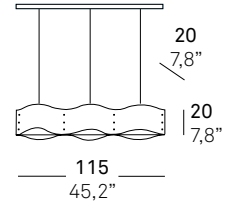

USA



3 x Globe CFL 15W
Medium Base
or
3 x G-25 100W max.
incandescent

10 Lb
Box size:
47x12x13"



Up-Charge Option
3 x Spiral CFL 15W
GU-24 Base



OLA+2 S CHW



WORLD



6 x 11 w
E-27
CFL short
Double tube /
Bajo consumo

Shades / **Pantallas**
boxes 1-2 /
cajas 1-2:
4,3 Kg/each (ud)
0,115 m³/each (ud)
120x30x32 cm/each (ud)

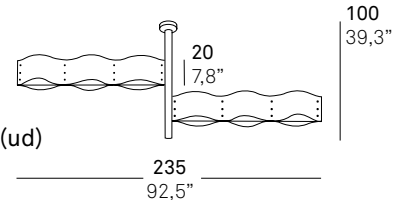

Mast / **Mástil**
box 3 / **caja 3:**
6 Kg
0,115 m³
120x30x32 cm

USA



6 x Globe CFL 15W
Medium Base
or
6 x G-25 100W max.
incandescent

Shades (box 1-2):
10 Lb/each.
Box size:
47x12x13"/each.



Up-Charge Option
6 x Spiral CFL 15W
GU-24 Base

Mast (box 3):
14 Lb
Box size:
47x12x13"



HOLA/HOLA MASTIL Miguel Herranz

SUSPENSION
SUSPENSIÓN

INFO

Electrical

Packaging

Dimension

OLA+10 S CHW

Shade / Pantalla

Natural wood /
Madera natural
CHW colors:

20 21 22 24
25 26 27 29
see chart /
ver gráfico

Required /
Requiere
shade mounting /
montaje de
pantalla



WORLD

30 x 11 w
E-27
CFL short
Double tube /
Bajo consumo



USA

30 x Globe CFL 15W
Medium Base
or
30 x G-25 100W max.
incandescent



Up-Charge Option

30 x Spiral CFL 15W
GU-24 Base



Shades / Pantallas

boxes 1-10 /
cajas 1-10:
43 Kg/each (ud)
0,115 m³/each (ud)
120x30x32 cm/each (ud)

Mast / Mástil
box 11 / caja 11:
12 Kg
0,115 m³
120x30x32 cm

Shades (box 1-10):
10 Lb/each
Box size:
47x12x13"/each

Mast (box 11):
27 Lb
Box size:
91x4x4"

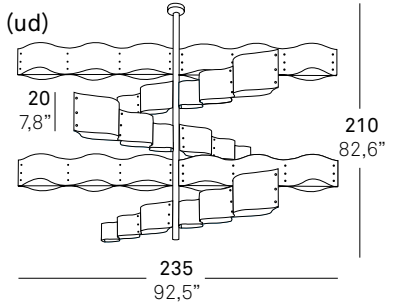

HOLA/HOLA MASTIL Miguel Herranz



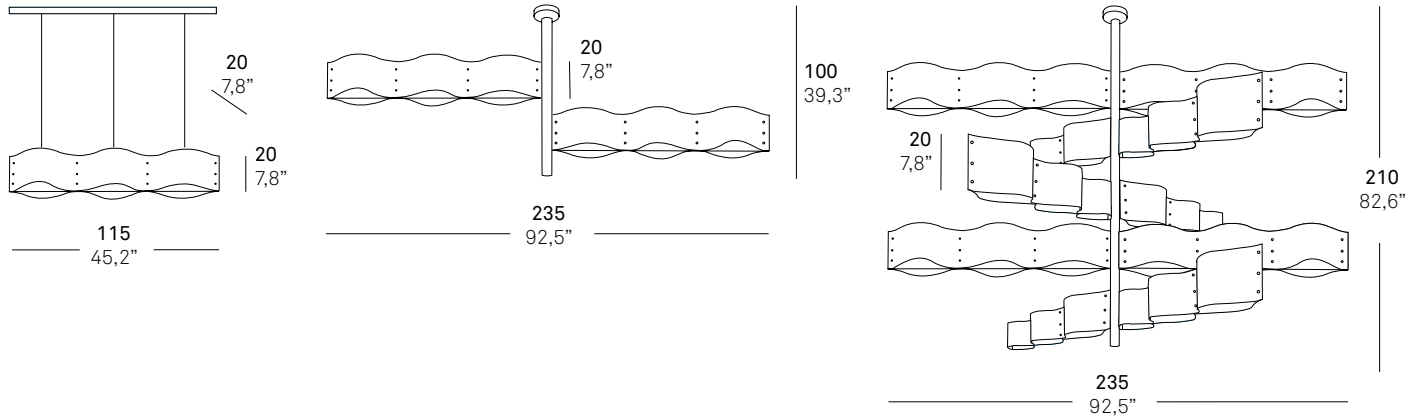



FAMILY / FAMILIA



SHADE FINISHES / ACABADOS PANTALLAS

REF. CHW

Natural timber veneer **Madera natural**

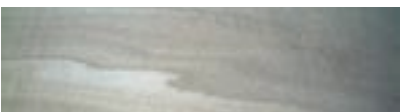
	CHW-20 American white wood Bolivar blanco		CHW-25 Orange Naranja
	CHW-21 Cherry Cerezo		CHW-26 Red Roja
	CHW-22 Beech Haya		CHW-27 Green Verde
	CHW-24 Yellow Amarillo		CHW-29 Grey Gris



Hola/Hola Mastil
Miguel Herranz



Hola/Hola Mastil
Miguel Herranz



Hola/Hola Mastil
Miguel Herranz



Hola/Hola Mastil
Miguel Herranz



Hola/Hola Mastil
Miguel Herranz



Hola/Hola Mastil
Miguel Heranz

Handmade

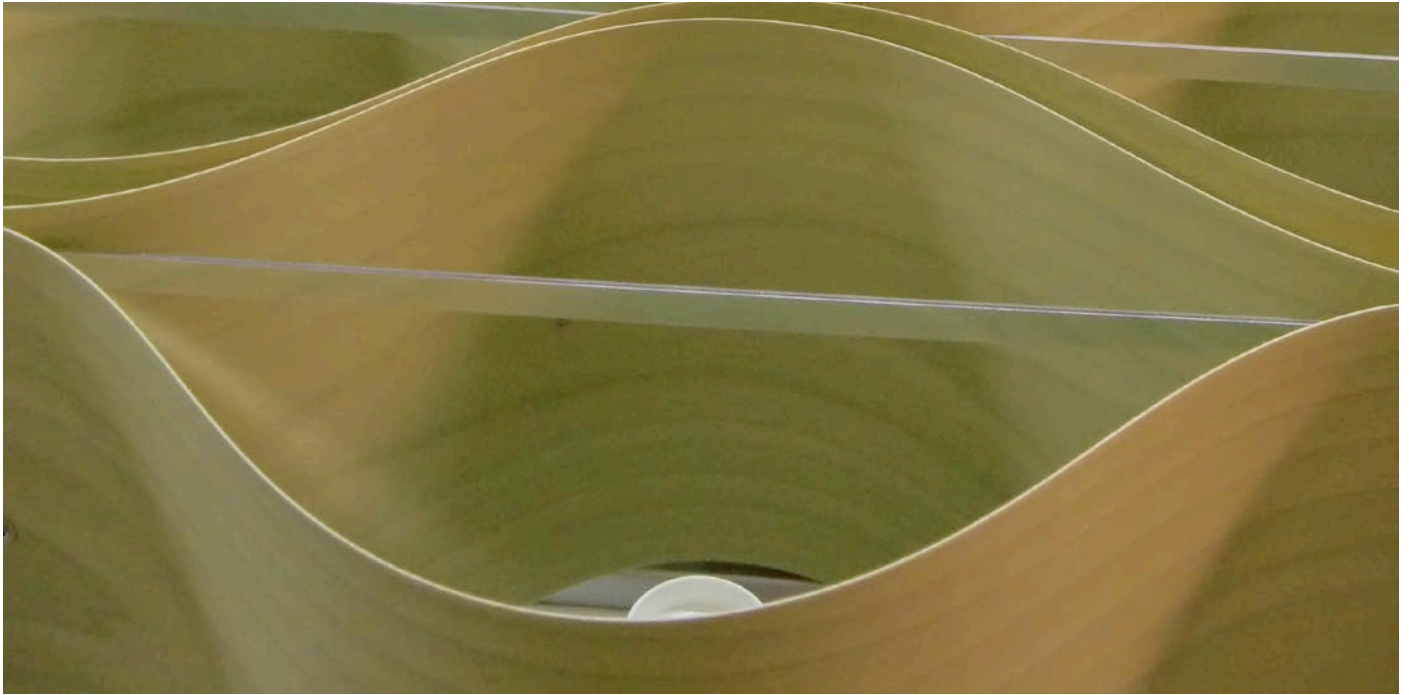

Hola/Hola Mastil
Miguel Herranz



Hola/Hola Mastil
Miguel Herranz

