

I club Book





## I-CLUB

Burkhard Dämmer

### **I-Club, belleza y exactitud**

La familia I-Club destaca por su contundente horizontalidad y elegancia. Su diseñador, Burkhard Dämmer, consigue que, por sus cualidades lumínicas y su manera de crear ambientes agradables, pueda utilizarse para entornos laborales o de ocio, así como para espacios públicos o privados.

Al estar equipada con tecnología electrónica, el consumo energético es mínimo y combina la calidez ambiental y la potencia lumínica de las lámparas fluorescentes.

La serie Club está disponible en varias versiones: suspensión, pie, mesa y aplique.

### ***I-Club, beauty and precision***

*The I-Club family stands out by a marked horizontality and elegance. Designer Burkhard Dämmer has created a lamp that, thanks to its lighting quality and unique warmth, is a good option for working or leisure environments alike, as well as for public and private interiors.*

*Club incorporates state-of-the-art electronic technology that guarantees a minimum electrical consumption, combining the warmth of ambient lighting with the power and quality of fluorescent lamp.*

*The Club series is available in hanging, floor, table and wall versions.*

I-CLUB Burkhard Dämmer

PENDANT  
SUSPENSIÓN

I S CHW



INFO

Shade / Pantalla

Natural wood / **Madera natural**  
CHW colors:  
20 21 22 24  
25 26 27 29  
see chart / ver gráfico

Diffuser / **Difusor**  
satinice perspex / **de metacrilato satinado**

Consult for price on dimable version  
Electronic ballast  
Dali compatible/  
**Consultar precio para versión dimable**  
**Balastro electrónico Dali compatible**

Family / **Familia**  
pendant, floor, table and wall / **susp, pie, mesa y aplique**

Electrical

WORLD

1 x 54 w  
T-5  
linear fluorescent included / **fluorescente lineal incluido**

USA

1 x 54 w  
T-5  
linear fluorescent not included



Packaging

Box / **Caja:**  
5 Kg  
30x30x150 cm

Dimension

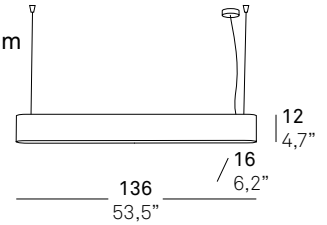

I SG CHW



WORLD

2 x 49 w  
T-5  
linear fluorescent included / **fluorescente lineal incluido**

USA

1 x 35 w  
T-5  
linear fluorescent not included



Box / **Caja:**  
10 Kg  
0,172 m<sup>3</sup>

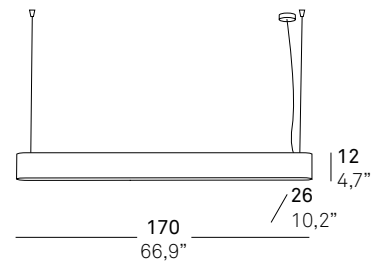

FLOOR  
PIE

I P CHW

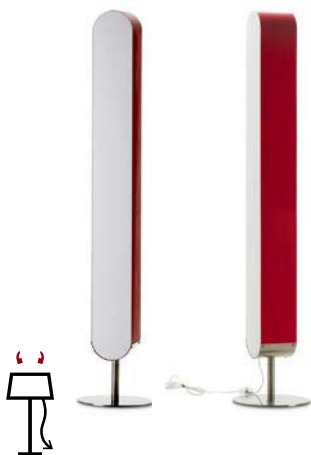

WORLD

1 x 54 w  
T-5  
linear fluorescent included / **fluorescente lineal incluido**

USA

1 x 54 w  
T-5  
linear fluorescent not included

120v only







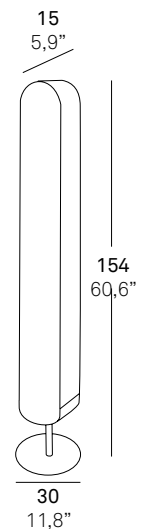





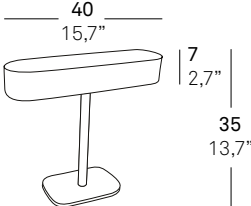

Box / **Caja:**  
6 Kg  
0,172 m<sup>3</sup>

1 box:  
- Shade  
- Base  
13,22 Lb  
Box size:  
12x13x70"

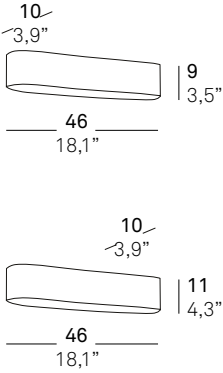

I-CLUB Burkhard Dämmer

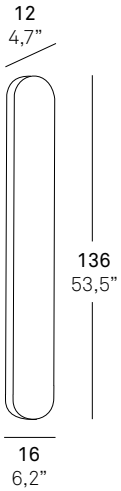
TABLE MESA	INFO	Electrical	Packaging	Dimension
<p>I M CHW</p> 	<p>Shade / Pantalla</p> <p>Natural wood / <b>Madera natural</b> CHW colors:              20 21 22 24            25 26 27 29            see chart / <b>ver gráfico</b></p>	<p><b>WORLD</b>   3 x 9 w            GX-53            CFL Hockey Puck / <b>pastilla fluorescente</b></p> <p><b>USA</b>   3 x 9 w            GX-53            CFL Hockey Puck</p>	<p>Box / Caja:            3,5 Kg            0,075 m<sup>3</sup>            50x50x30 cm</p> <p>4 Lb            Box size:            20x20x12"</p>	
<p>WALL APLIQUE</p> <p>I A CHW</p> 	<p>Diffuser / <b>Difusor</b>            satinice perspex / <b>de metacrilato satinado</b></p> <p>Consult for price on dimable version            Electronic ballast            Dali compatible/  <b>Consultar precio para versión dimable</b>  <b>Balastro electrónico Dali compatible</b></p> <p>Family / <b>Familia</b>            pendant, floor, table and wall / <b>susp, pie, mesa y aplique</b></p>	<p>120v only</p> <p>Bulb included</p> <p></p> <p><b>WORLD</b>   2 x 8w            T-5            linear fluorescent included. Not dimable/  <b>fluorescente lineal. incluido. No dimable</b></p> <p><b>USA</b>   2 x 8w            T-5            linear fluorescent not included</p>	<p>Box / Caja:            2 Kg            0,028 m<sup>3</sup>            49x29x20cm</p> <p>5 Lb            Box size:            20x12x8"</p>	
<p>I AG CHW</p> 	<p>Family / <b>Familia</b>            pendant, floor, table and wall / <b>susp, pie, mesa y aplique</b></p>	<p><b>WORLD</b>   1 x 54 w            T-5            linear fluorescent included / <b>fluorescente lineal incluido</b></p> <p><b>USA</b>   1 x 54 w            T-5            linear fluorescent not included</p> <p>120v - 277v            multivolt ballast</p> <p></p>	<p>Box / Caja:            10 Kg            0,172 m<sup>3</sup></p> <p>22 Lb            Box size:            12x13x70"</p>	

I-CLUB Burkhard Dämmer



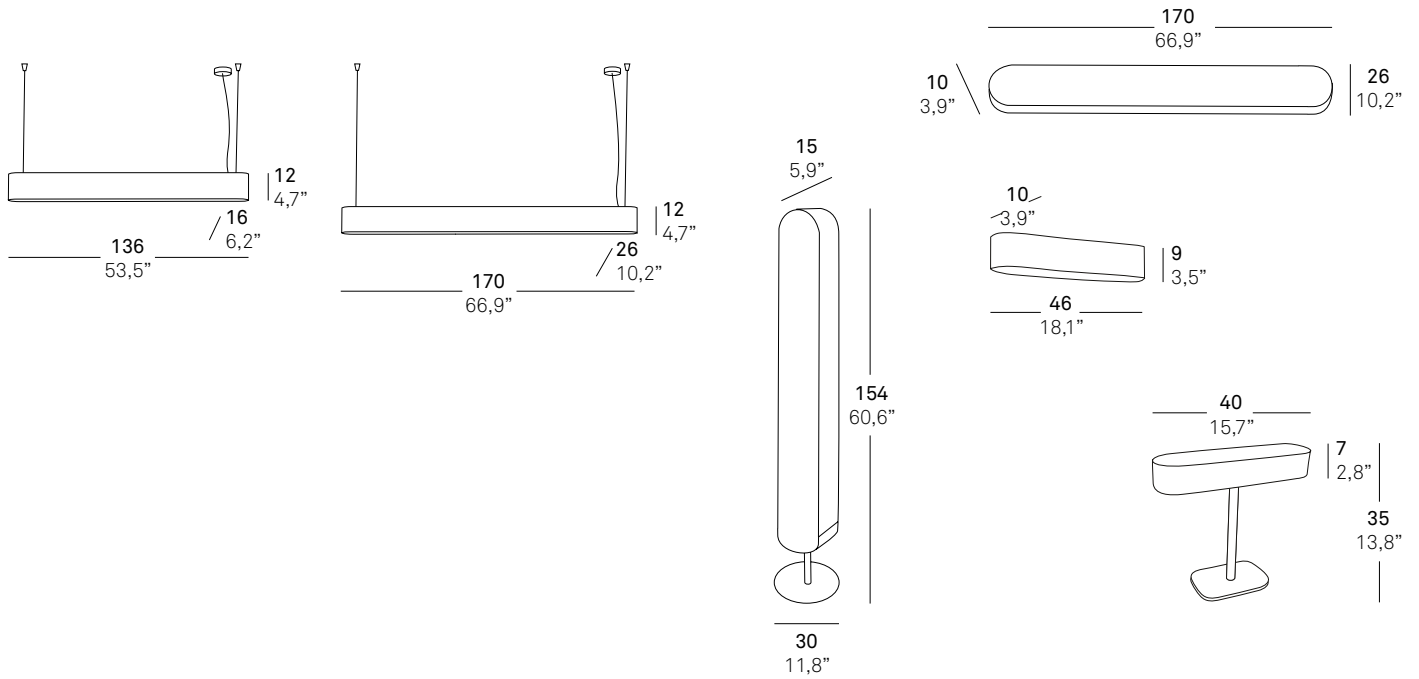





FAMILY / FAMILIA



SHADE FINISHES / ACABADOS PANTALLAS

REF. CHW

Natural timber veneer **Madera natural**

	<b>CHW-20</b> American white wood Bolivar blanco		<b>CHW-25</b> Orange Naranja
	<b>CHW-21</b> Cherry Cerezo		<b>CHW-26</b> Red Roja
	<b>CHW-22</b> Beech Haya		<b>CHW-27</b> Green Verde
	<b>CHW-24</b> Yellow Amarillo		<b>CHW-29</b> Grey Gris





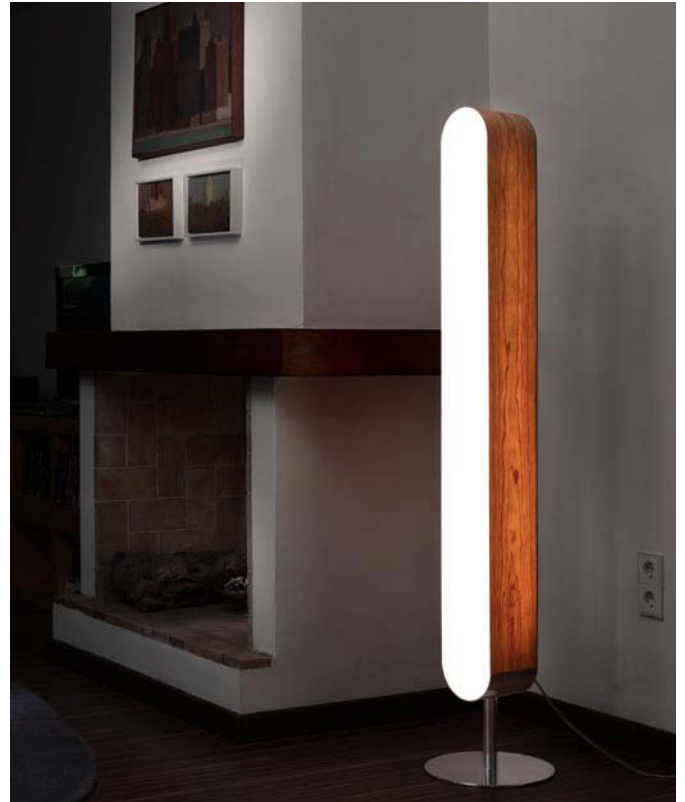
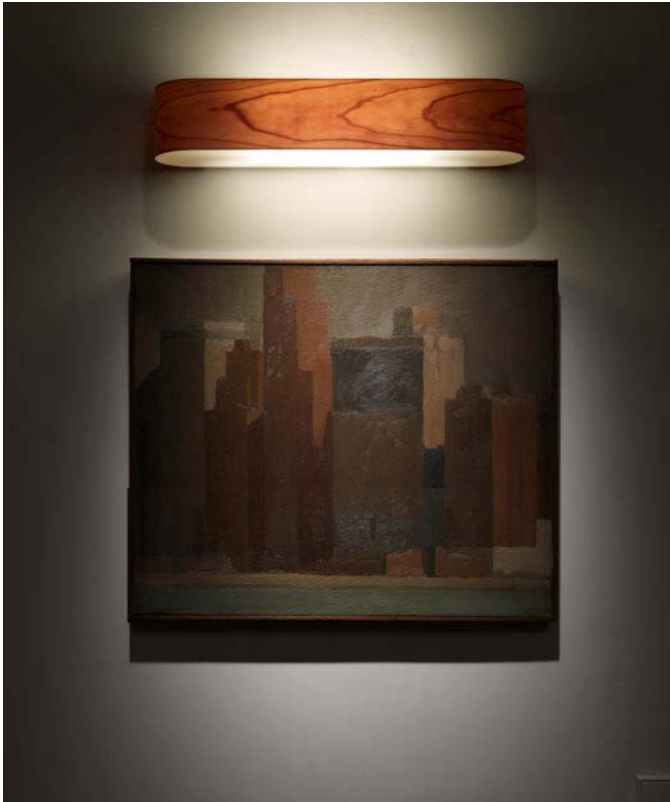





**I-Club**  
Burkhard Dämmer

# Händmade



**I-Club**  
Burkhard Dämmer

