

**2011**

---

pdf

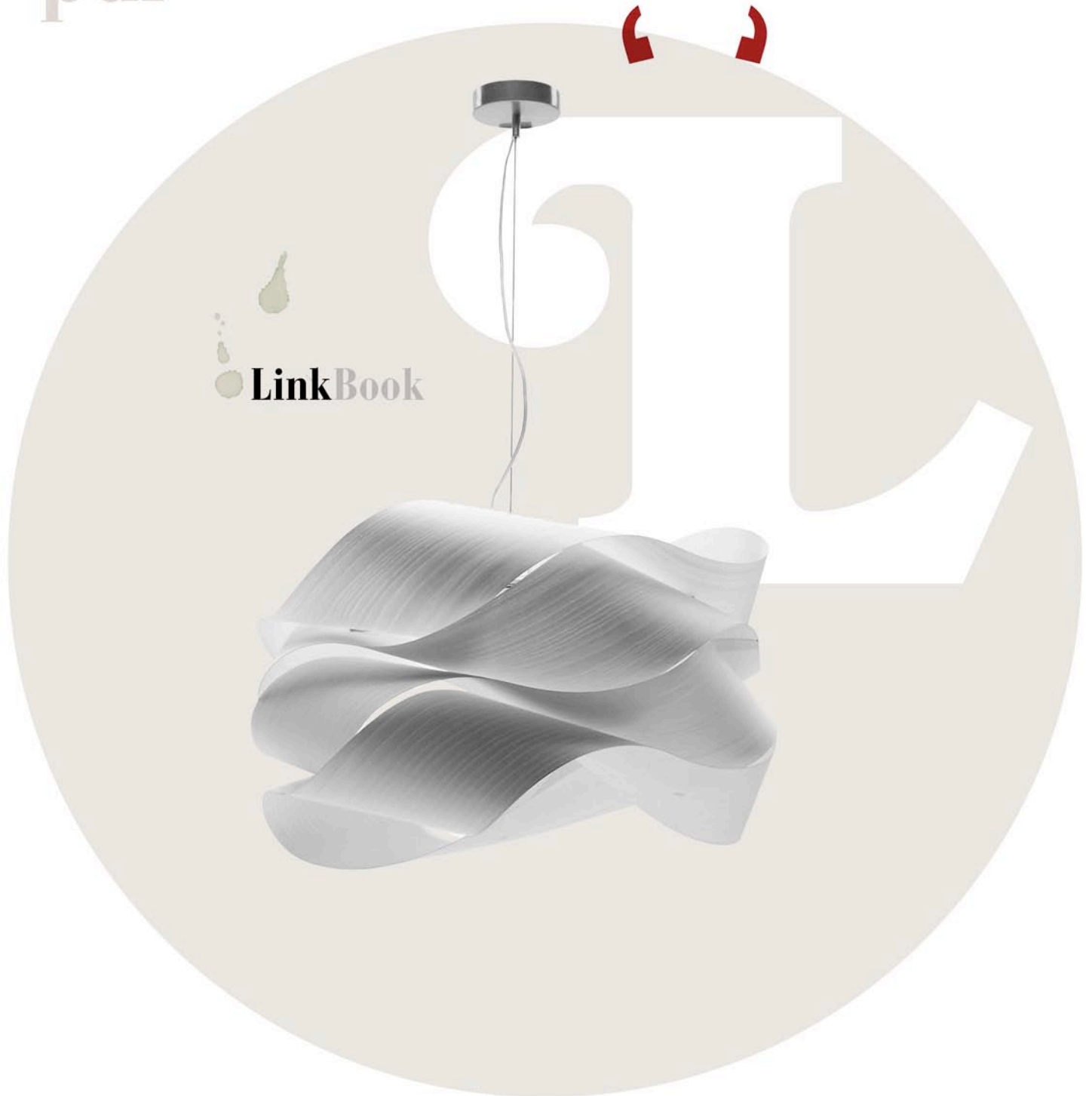

REV-08-2011

**lzf**  
HANDMADE





Ray Power

### **Link, geometry for the senses**

Irishman Ray Power designed the Link family for LZF with a rigorous study of form and geometry. Made up of Moebius strips piled on top of one another, it confers great warmth thanks to an interesting light and shadow play.

Link has been awarded the Design Plus Material Vision'07 award for the use of LZF's famous Polywood®.

### **Link, geometría sensorial**

*El irlandés Ray Power ha diseñado para LZF la familia de lámparas Link. Con un afinado estudio de la forma y la geometría - formada por un conjunto de cintas de moebius-, el resultado es una luz cálida, con un intenso juego de luces y sombras.*

*Link ha sido merecedora del premio Design Plus Material Vision'07, por el uso que realiza de la chapa tratada de LZF, Polywood®.*

## LINK Ray Power

PENDANT  
SUSPENSIÓN

LK SP CHW



### INFO

#### Shade / Pantalla

Natural wood /  
**Madera natural**

CHW colors:  
20 21 22 24



25 26 27 29  
see chart / ver gráfico

Family / Familia  
pendant and floor  
**susp y pie**

#### Awards / Premios



Chicago 2008

**DESIGN PLUS**

Frankfurt 2007

### Electrical



#### WORLD

1 x 20 w  
E-27  
Ø95  
CFL globe /  
**Globo bajo consumo**



#### USA

1 x Globe CFL 15W  
Medium Base  
or  
1 x G-25 100W max.  
incandescent

#### Up-Charge Option

1 x 15W CFL 15W GU-24



### Packaging

Box / Caja:  
2,76 Kg  
0,075 m<sup>3</sup>  
50x50x30 cm

6 Lb  
Box size:  
20x20x12"

### Dimension

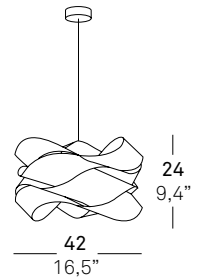

LK SM CHW



#### WORLD

1 x 20 w  
E-27  
Ø95  
CFL globe /  
**Globo bajo consumo**



#### USA

1 x Globe CFL 15W  
Medium Base  
or  
1 x G-25 100W max.  
incandescent

#### Up-Charge Option

1 x 15W CFL 15W  
GU-24



Box / Caja:  
5 Kg  
0,150 m<sup>3</sup>  
50x50x60 cm

11 Lb  
Box size:  
20x20x24"

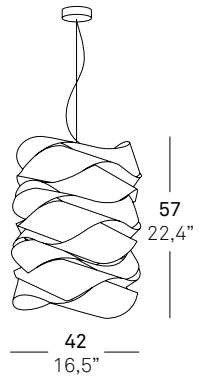

LINK Ray Power

PENDANT  
SUSPENSIÓN

LK SG CHW



INFO

Shade / Pantalla

Natural wood /  
**Madera natural**  
CHW colors:  
20 21 22 24  
25 26 27 29  
see chart / ver gráfico

Family / Familia  
pendant and floor  
**susp y pie**

Awards / Premios



Chicago 2008

**DESIGN PLUS**  
Frankfurt 2007

Electrical



**WORLD**  
1 x 20 w  
E-27  
Ø95  
CFL globe /  
**Globo bajo consumo**



**USA**  
1 x Globe CFL 15W  
Medium Base  
or  
1 x G-25 100W max.  
incandescent

Up-Charge Option  
1 x 15W CFL 15W  
GU-24



Packaging

Box / Caja:  
6,7 Kg  
0,225 m<sup>3</sup>  
75x75x40 cm

15 Lb  
Box size:  
30x30x24"

Dimension

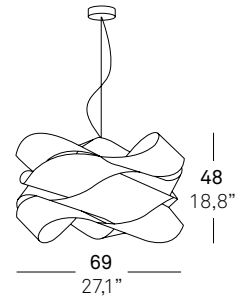

FLOOR  
PIE

LK P CHW



Shade / Pantalla

Natural wood /  
**Madera natural**  
CHW colors:  
20 21 22 24  
25 26 27 29  
see chart / ver gráfico

Required / Requiere  
shade to base mount /  
**montaje de pantalla a  
base**

Family / Familia  
pendant and floor /  
**susp y pie**

Awards / Premios



Chicago 2008

**DESIGN PLUS**  
Frankfurt 2007



**WORLD**  
1 x 20 w  
E-27  
Ø95  
CFL globe /  
**Globo bajo consumo**



**USA**  
1 x Globe CFL 15W  
Medium Base  
or  
1 x G-30 100W max.  
incandescent

Up-Charge Option  
1 x 15W CFL GU-24



Shade / Pantalla

Box 1 / Caja 1:  
3 Kg  
0,225 m<sup>3</sup>  
75x75x40 cm

Foot / Pie  
Box 2 / Caja 2:  
6 Kg  
0,400 m<sup>3</sup>  
50x50x160 cm

Shade (box 1)  
8 Lb  
Box size:  
30x30x16"

Foot (box 2)  
14 Lb  
Box size:  
20x20x63"

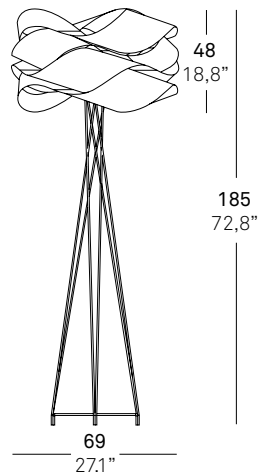

**LINK** Ray Power

FAMILY / FAMILIA

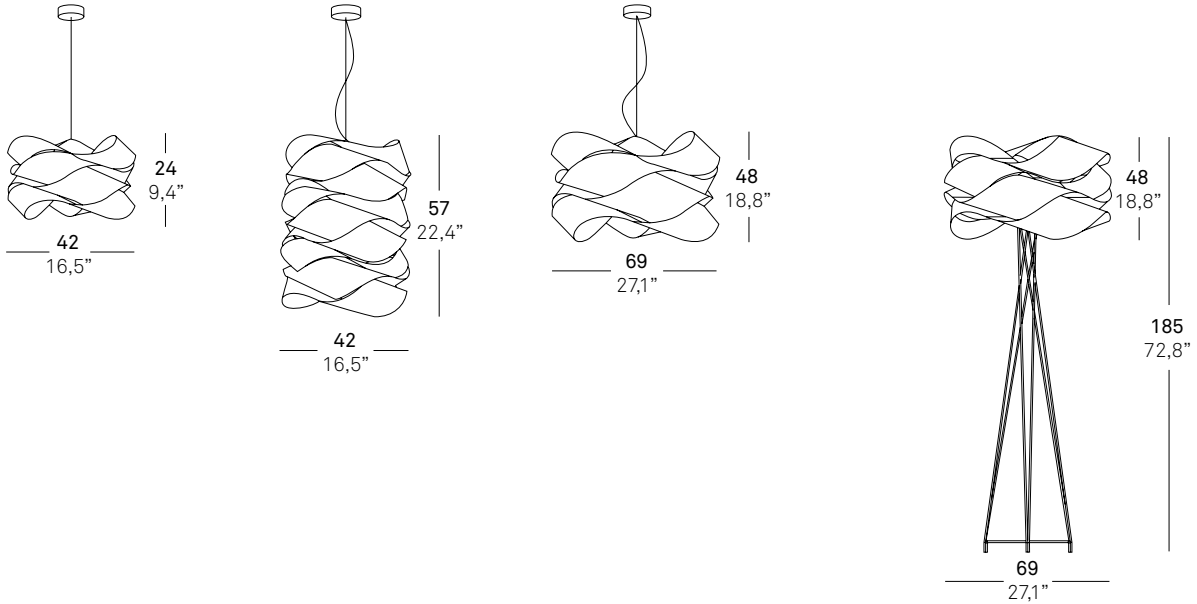

SHADE FINISHES / ACABADOS PANTALLAS

REF. CHW

Natural timber veneer **Madera natural**



**CHW-20**  
American white wood  
**Bolivar blanco**

**CHW-25**  
Orange  
**Naranja**

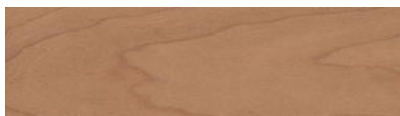

**CHW-21**  
Cherry  
**Cerezo**

**CHW-26**  
Red  
**Roja**



**CHW-22**  
Beech  
**Haya**

**CHW-27**  
Green  
**Verde**



**CHW-24**  
Yellow  
**Amarillo**

**CHW-29**  
Grey  
**Gris**





Link  
Ray Power







**Link**  
Ray Power



Link  
Ray Power



**Link**  
Ray Power

# Handmade



**Link**  
Ray Power



Link  
Ray Power

